

Art. Nr. 58396-17-5, 58396-A7-5

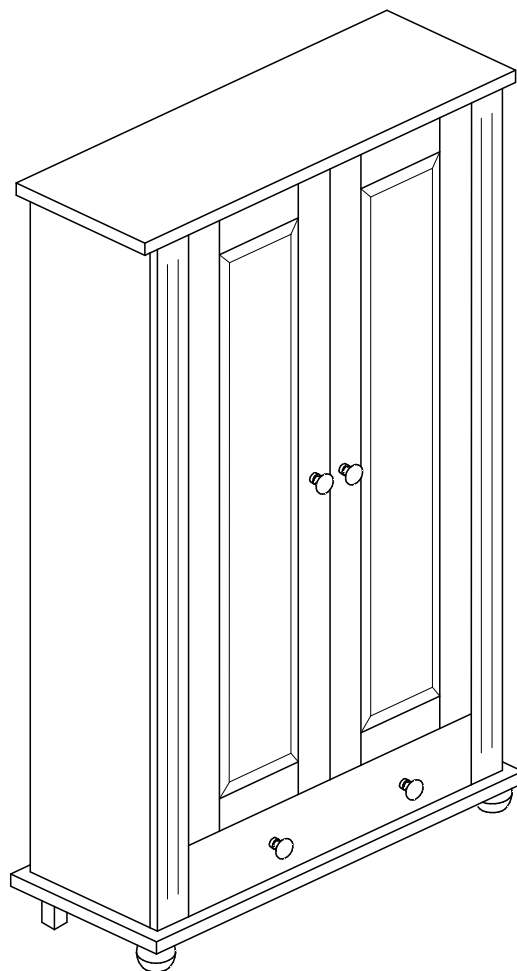

- | | | | |
|-------------|------------------------------------|-------------|--------------------------------|
| (D) | Montageanleitung | (GB) | Assembly instructions |
| (FR) | Notice de montage | (IT) | Istruzioni di montaggio |
| (NL) | Handleiding voor de montage | (PL) | Instrukcja montażu |
| (CZ) | Montážní návod | (SK) | Návod na montáž |
| (HU) | Szerelési útmutató | (RO) | Instrukțiuni de montaj |
| (TR) | Montaj talimatı | (RU) | Инструкция по монтажу |

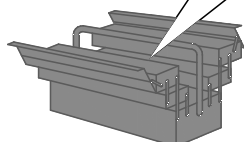
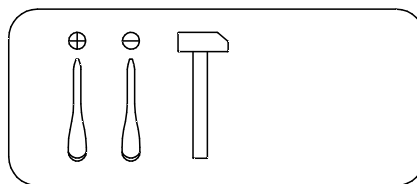
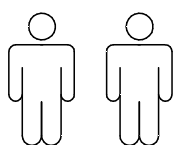

POL-POWER Sp. Z o.o

ul. Poznańska, 113 A
PL 62-052 Komorniki
Tel. +48 61 810 31
e-mail: info@pol-power.pl

POL-POWER

Verkausbüro Deutschland
Pyrmonter Strasse 78
D-32676 Lügde
Tel. +49 (0) 5281 947 752
e-mail: polpower@web.de

Service • Dienstverlening • Serwis • Servis • Сервисная служба

| |
|---|
| Name • Naam • Nazwa • Isim • Название |
| Nr. • No. • Номер |
| Тип • Type • Tip • Тип |
|  |

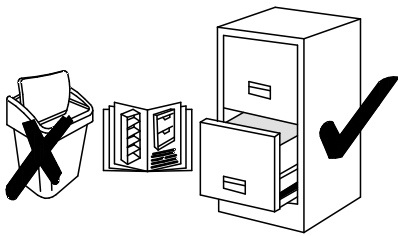
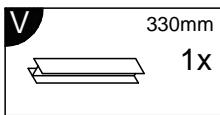
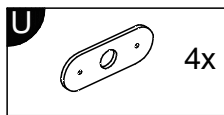
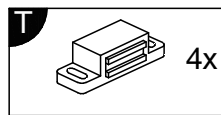
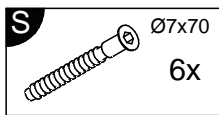
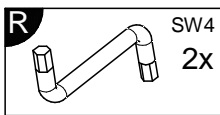
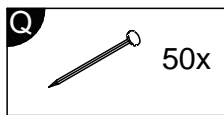
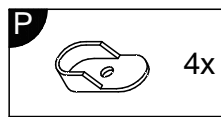
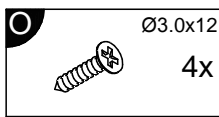
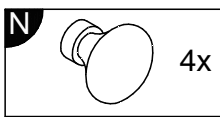
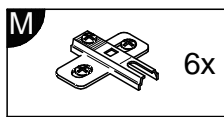
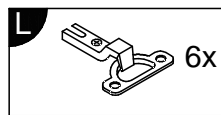
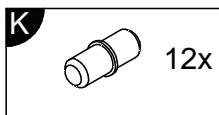
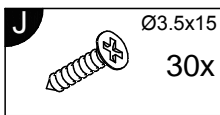
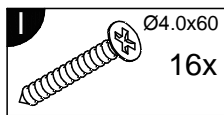
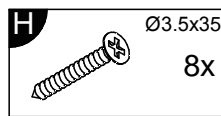
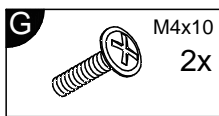
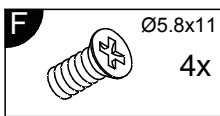
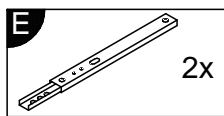
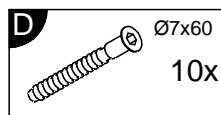
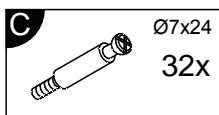
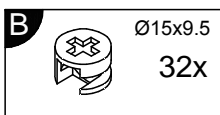
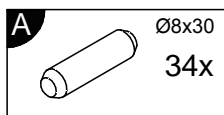
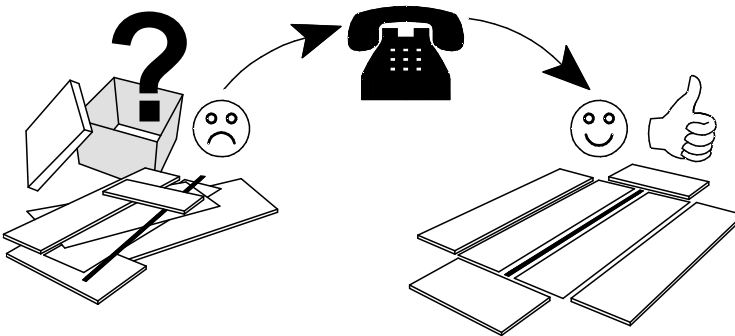

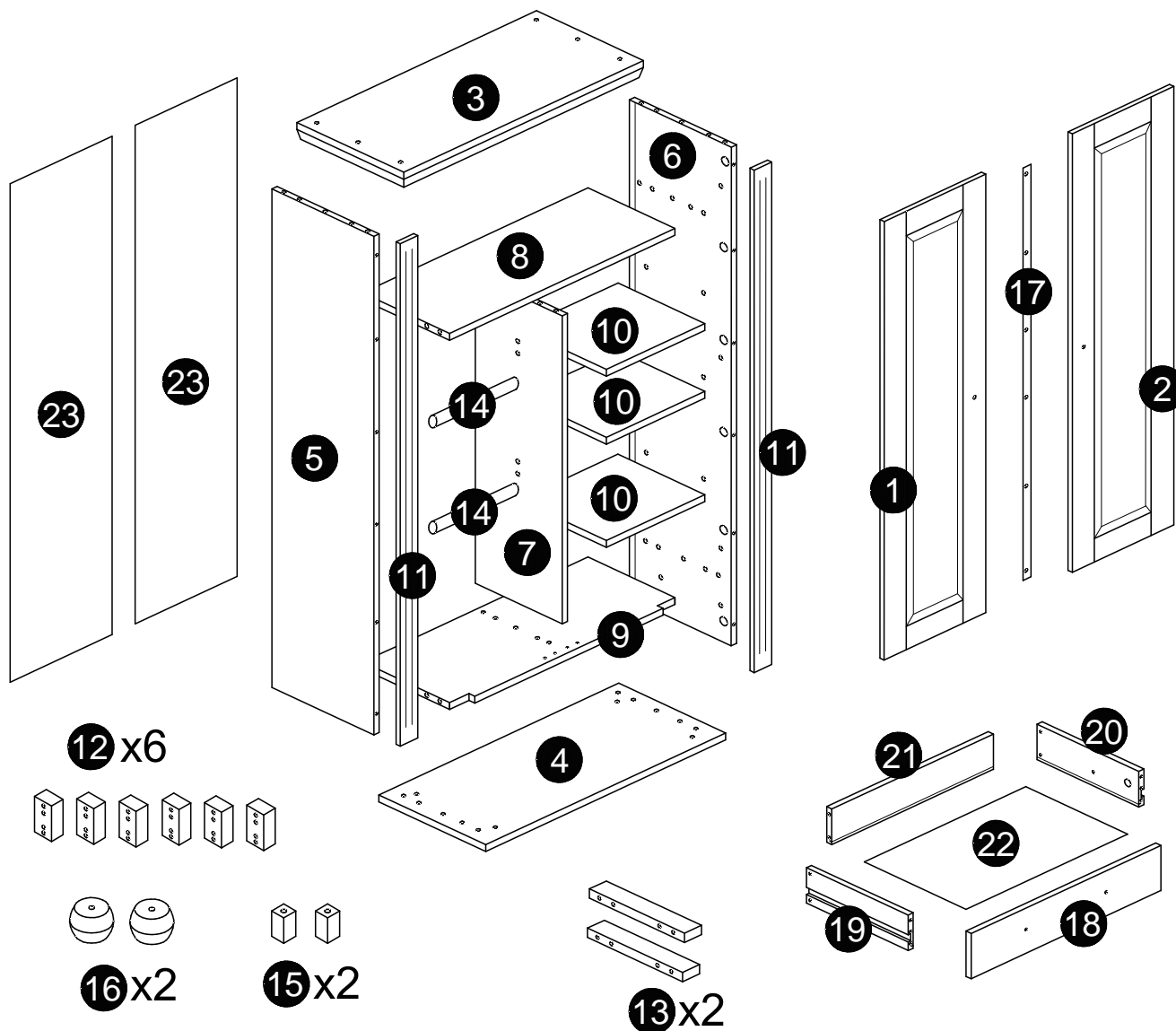



| Nr | Size/MaB (mm) | Qty | ✓ | Colli |
|----|-----------------|-----|---|-------|
| 1 | 1528 x 355 x 18 | 1 | | 2/2 |
| 2 | 1528 x 355 x 18 | 1 | | 2/2 |
| 3 | 930 x 548 x 44 | 1 | | 1/2 |
| 4 | 900 x 535 x 27 | 1 | | 1/2 |
| 5 | 1720 x 480 x 14 | 1 | | 2/2 |
| 6 | 1720 x 480 x 14 | 1 | | 2/2 |
| 7 | 1206 x 400 x 14 | 1 | | 1/2 |
| 8 | 830 x 405 x 14 | 1 | | 1/2 |
| 9 | 830 x 489 x 14 | 1 | | 1/2 |
| 10 | 407 x 395 x 18 | 3 | | 1/2 |
| 11 | 1720 x 80 x 14 | 2 | | 2/2 |
| 12 | 72 x 66 x 45 | 6 | | 1/2 |
| 13 | 328 x 66 x 24 | 2 | | 2/2 |
| 14 | 402 x 35 x 14 | 2 | | 1/2 |

| Nr | Size/MaB (mm) | Qty | ✓ | Colli |
|----|----------------|-----|---|-------|
| 15 | 60 x 40 x 40 | 2 | | 1/2 |
| 16 | 60 x 80 x 80 | 2 | | 1/2 |
| 17 | 1510 x 40 x 4 | 1 | | 2/2 |
| 18 | 713 x 186 x 18 | 1 | | 1/2 |
| 19 | 450 x 94 x 12 | 1 | | 1/2 |
| 20 | 450 x 94 x 12 | 1 | | 1/2 |
| 21 | 664 x 94 x 12 | 1 | | 1/2 |
| 22 | 673 x 446 x 4 | 1 | | 1/2 |
| 23 | 1768 x 424 x 4 | 2 | | 2/2 |
| | | | | |
| | | | | |
| | | | | |
| | | | | |

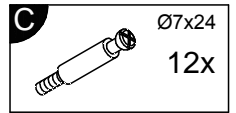
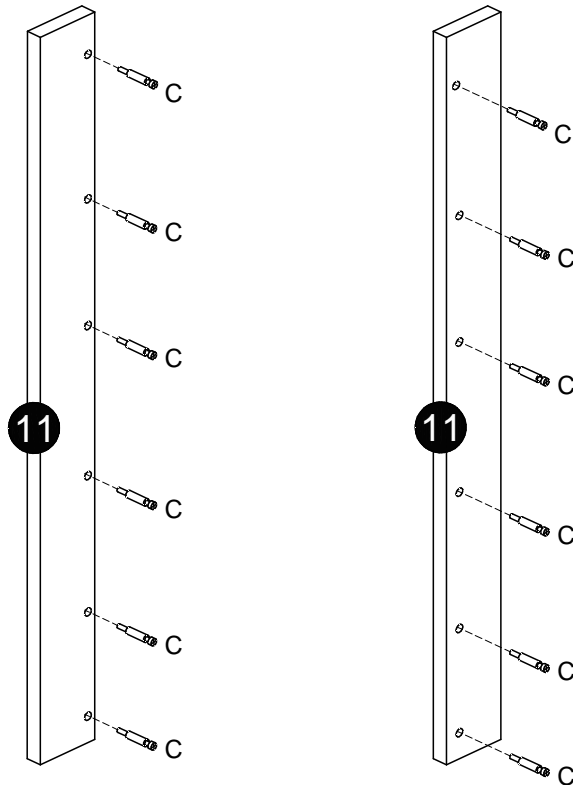
1



2

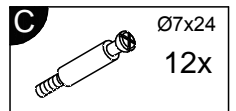
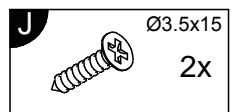
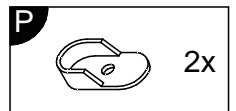
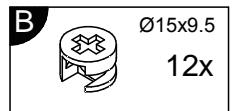
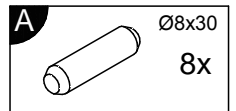
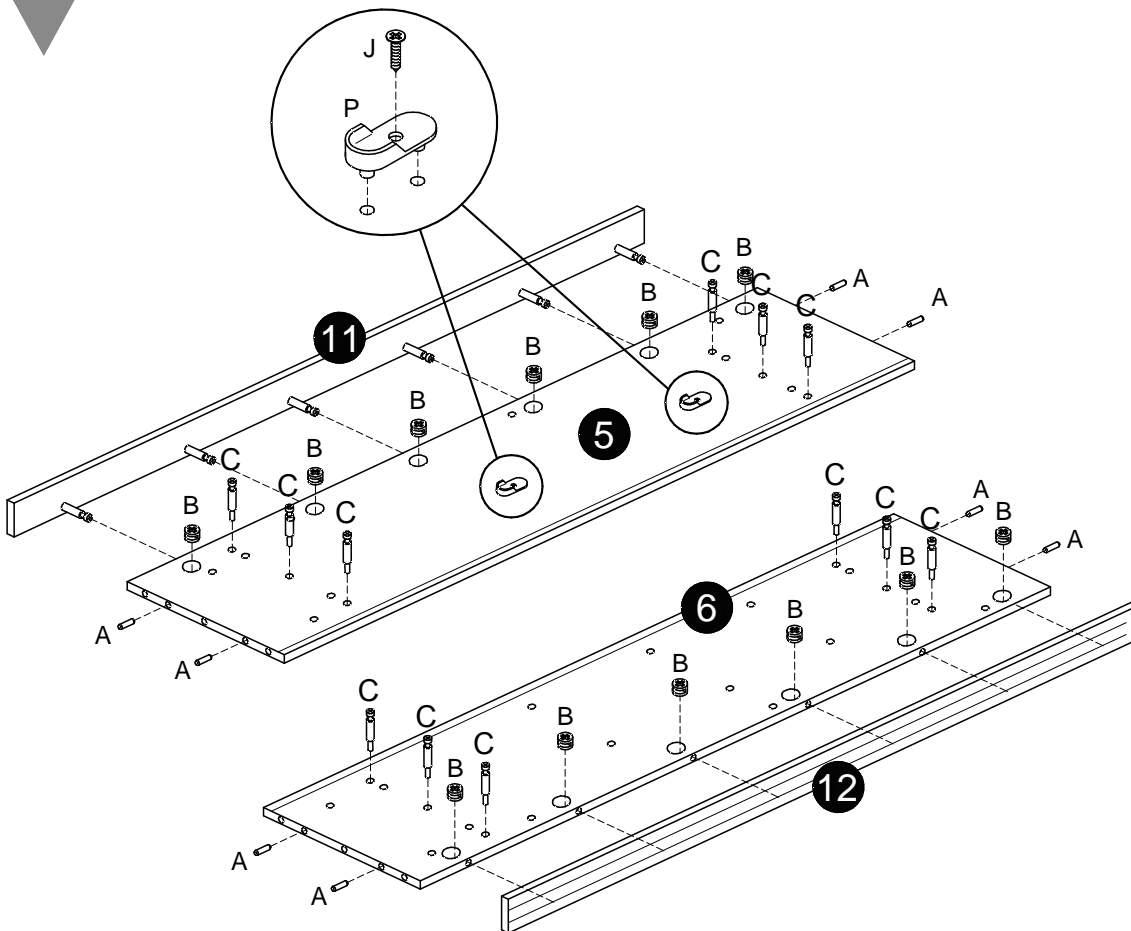

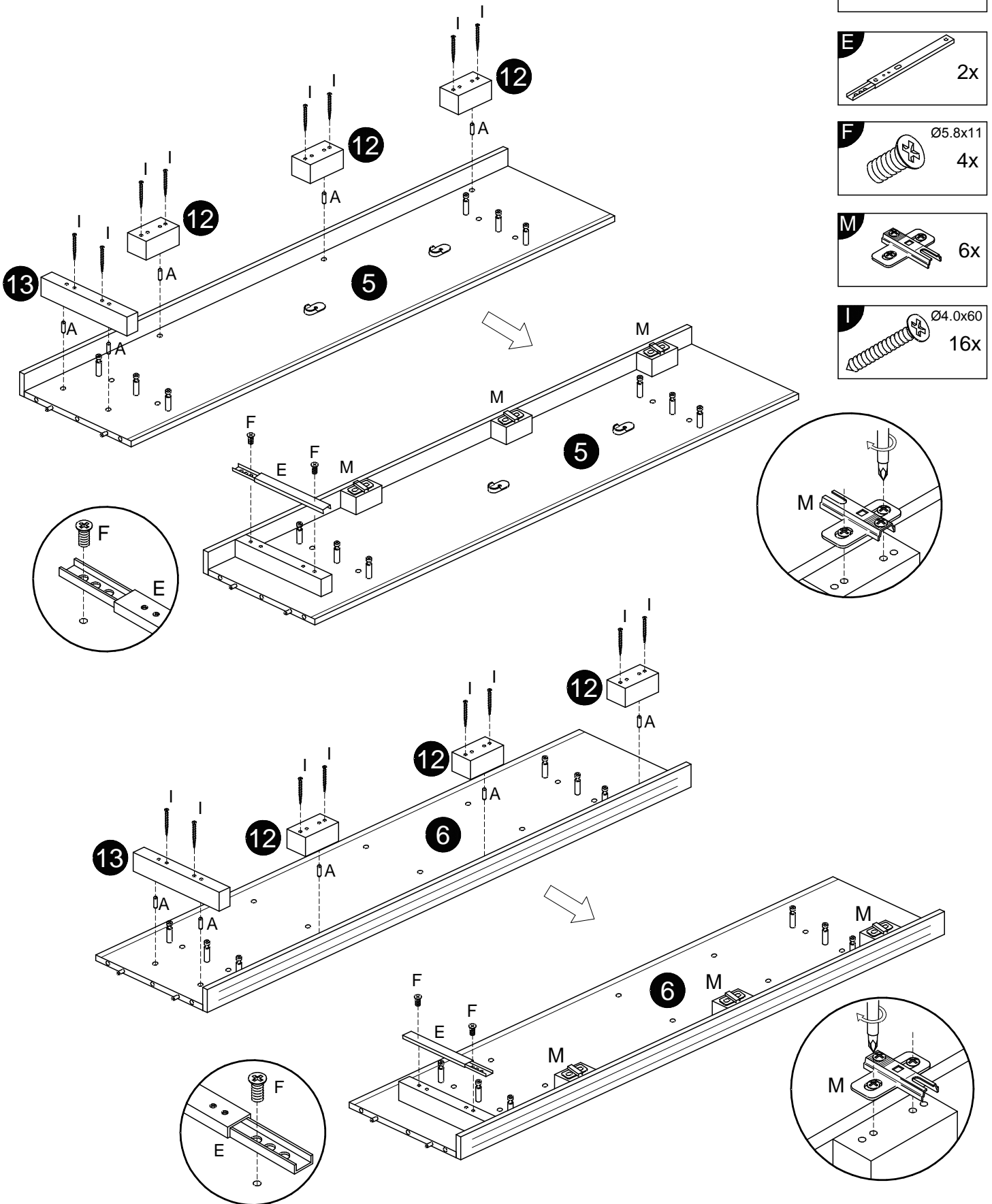

A Ø8x30
10x

E 2x

F Ø5.8x11
4x

M 6x

L Ø4.0x60
16x

4

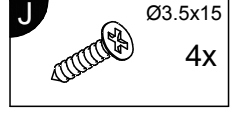
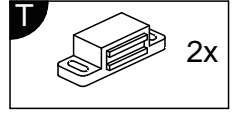
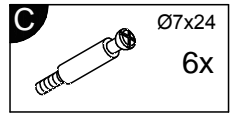
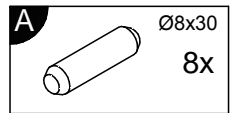
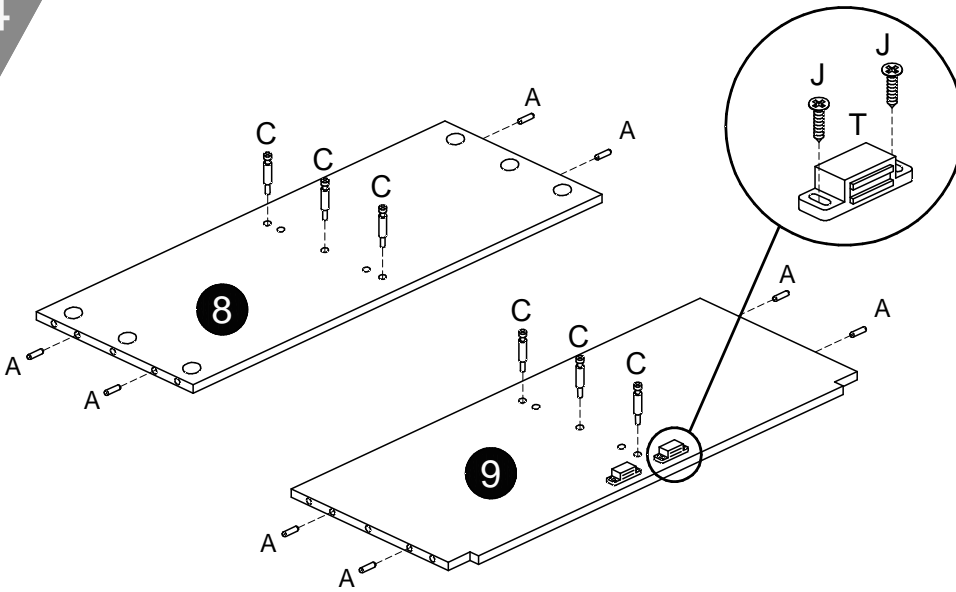

5

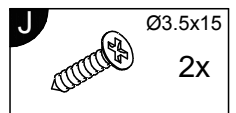
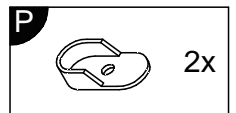
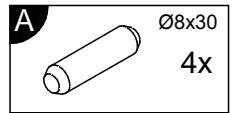
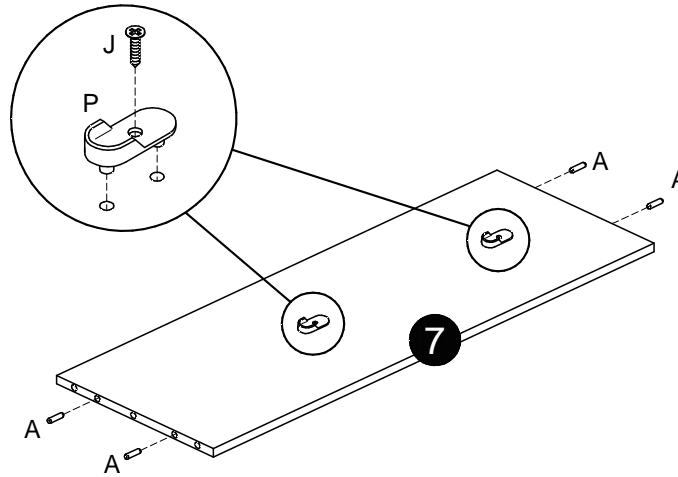

6

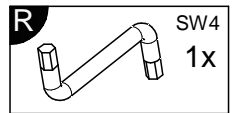
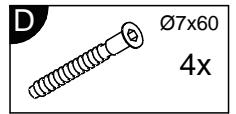
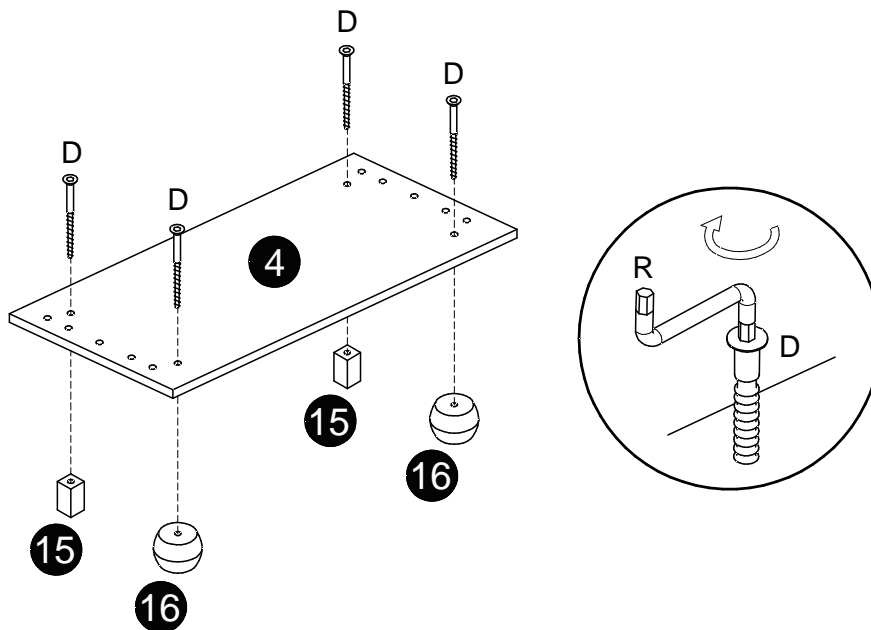

7

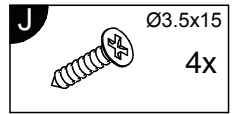
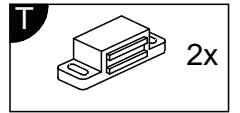
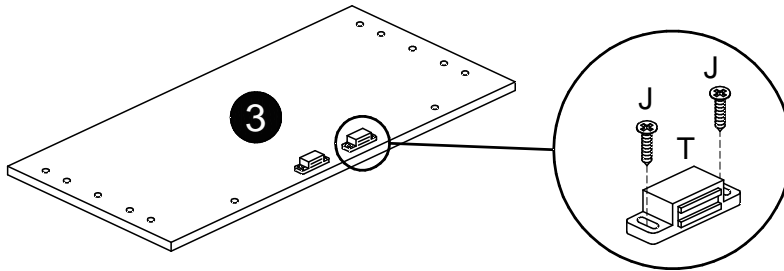

8

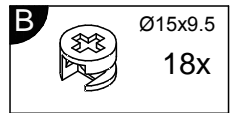
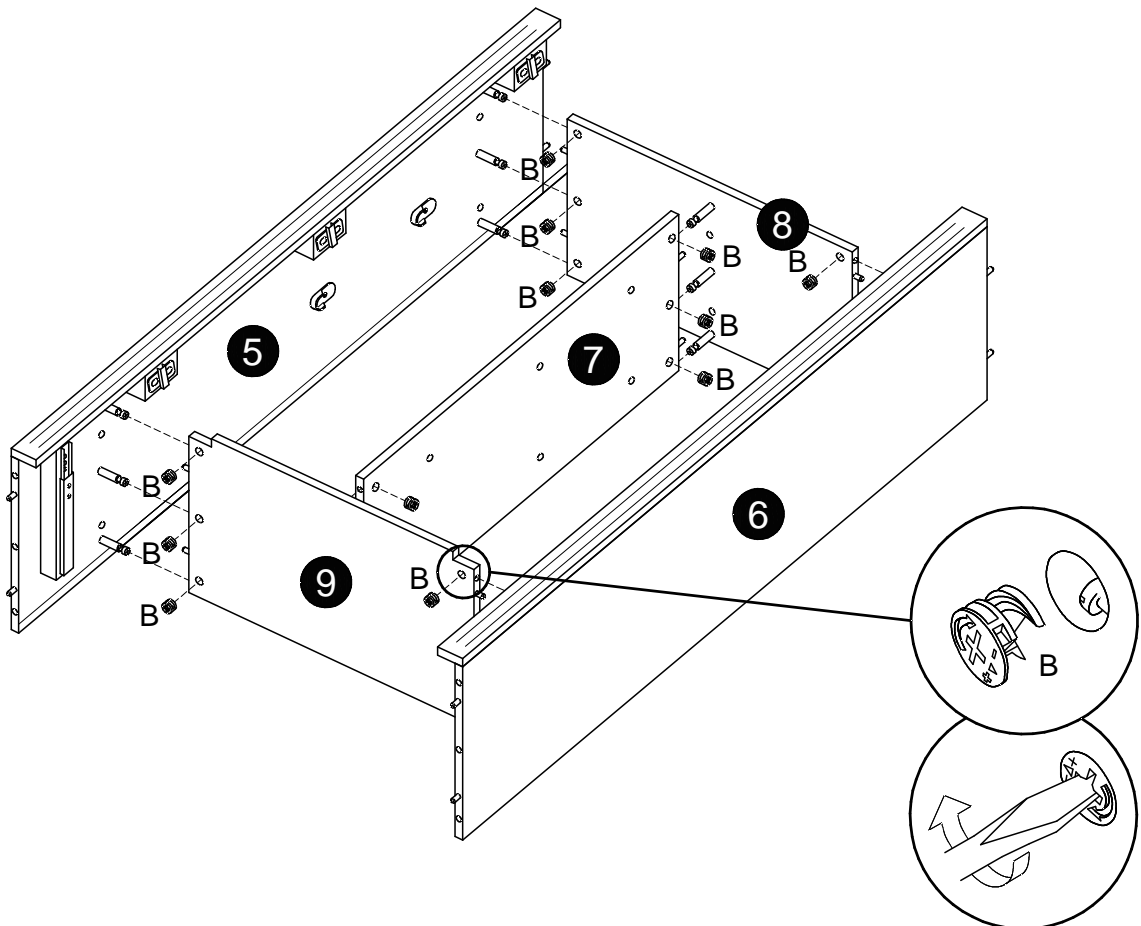

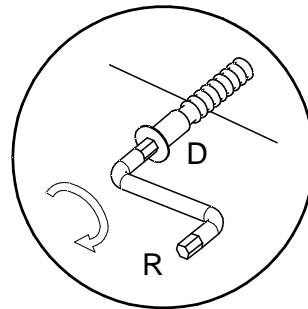
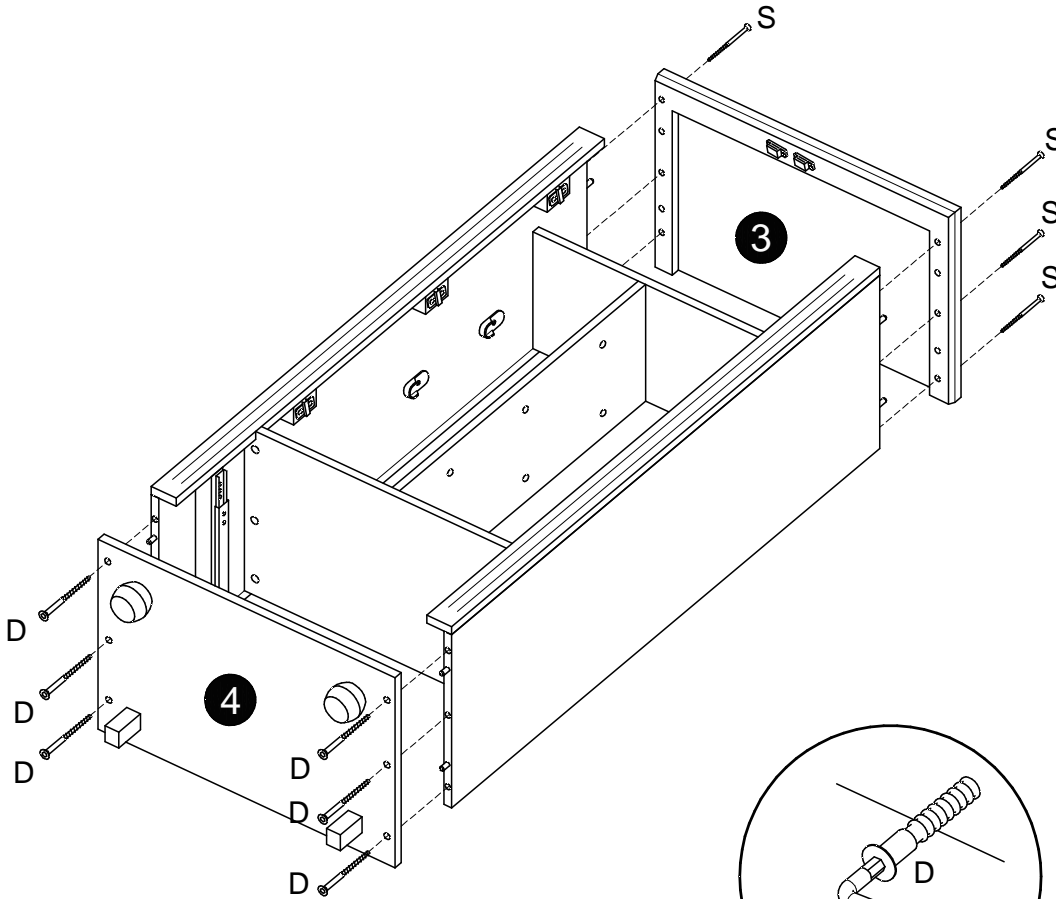
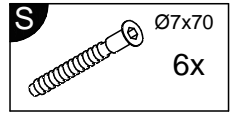
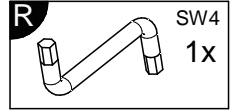
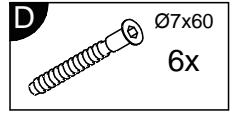

10

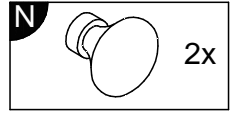
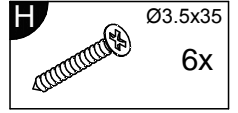
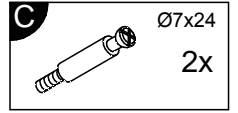
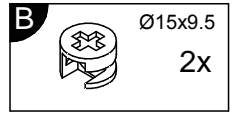
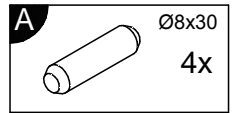
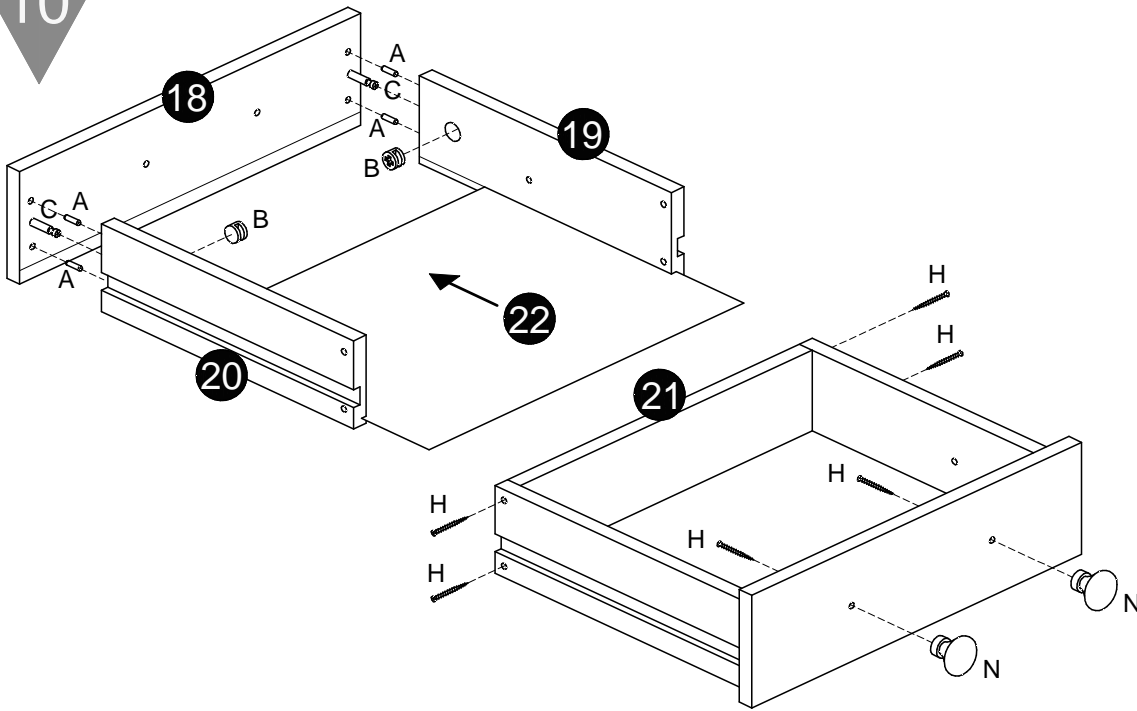

11

