

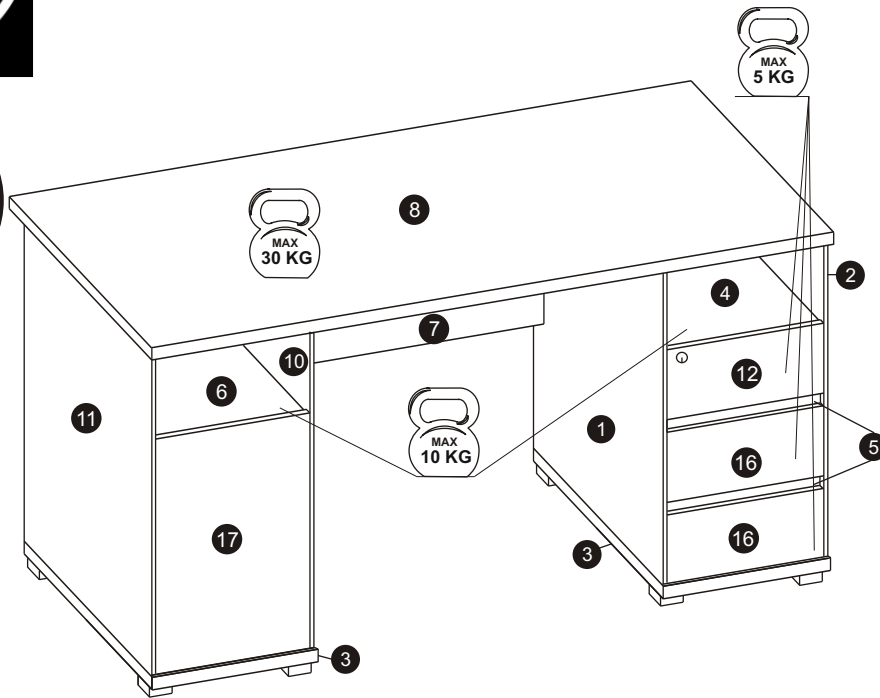

wyprodukowano dla / made for / produziert für
BEGA GRUPPE
 producent: **MEBLE OKMED** POLAND

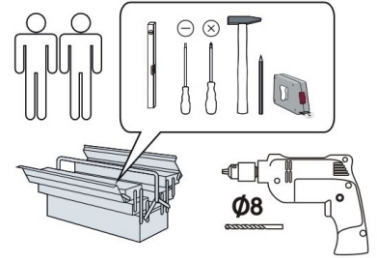

2/2

	B	H	T	
14	350	110	16	x3
13	350	110	16	x3
3	400	600	22	x2
17	362	526	16	x1
12	362	155	16	x1
16	362	155	16	x2
5	367	60	16	x2
7	640	250	16	x1
18	367	540	16	x1
15	328	95	16	x3
6	367	545	16	x1
4	367	545	16	x1

1/2

	B	H	T	
8	1450	650	22	x1
11	687	580	16	x1
10	687	580	16	x1
1	687	580	16	x1
2	687	580	16	x1
19	355	343	3	x3
9	700	385	3	x2

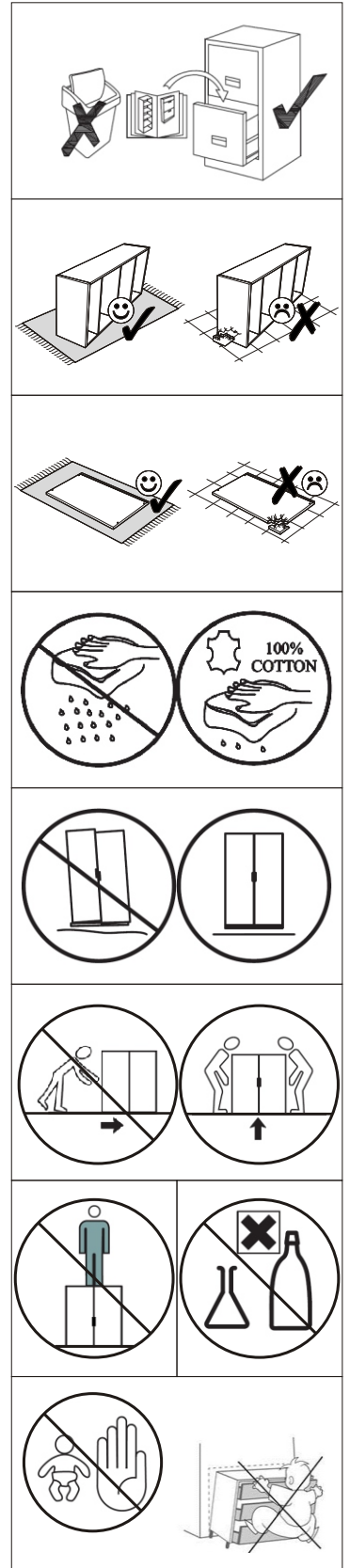
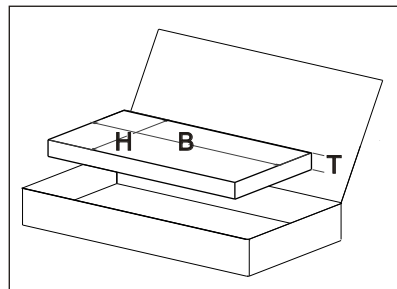
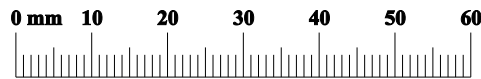

	ZM1	30		ZM1B	30		ZM1A	30		K1	14		ZK	14
	KK1	1		KD1	44		KSK1	1		W1	15		SS6	8
	PKU3	3		ME1	12		SR4	6		ZPM1	1		PP	4
	ZDW	2		ZDW1	2		W4	4						

01

ZM1A	ZM1B	KD1	PKU3	ME1	SS6
24	12	20	3	12	8
ZPM1	PP	ZDW			
1	4	2			

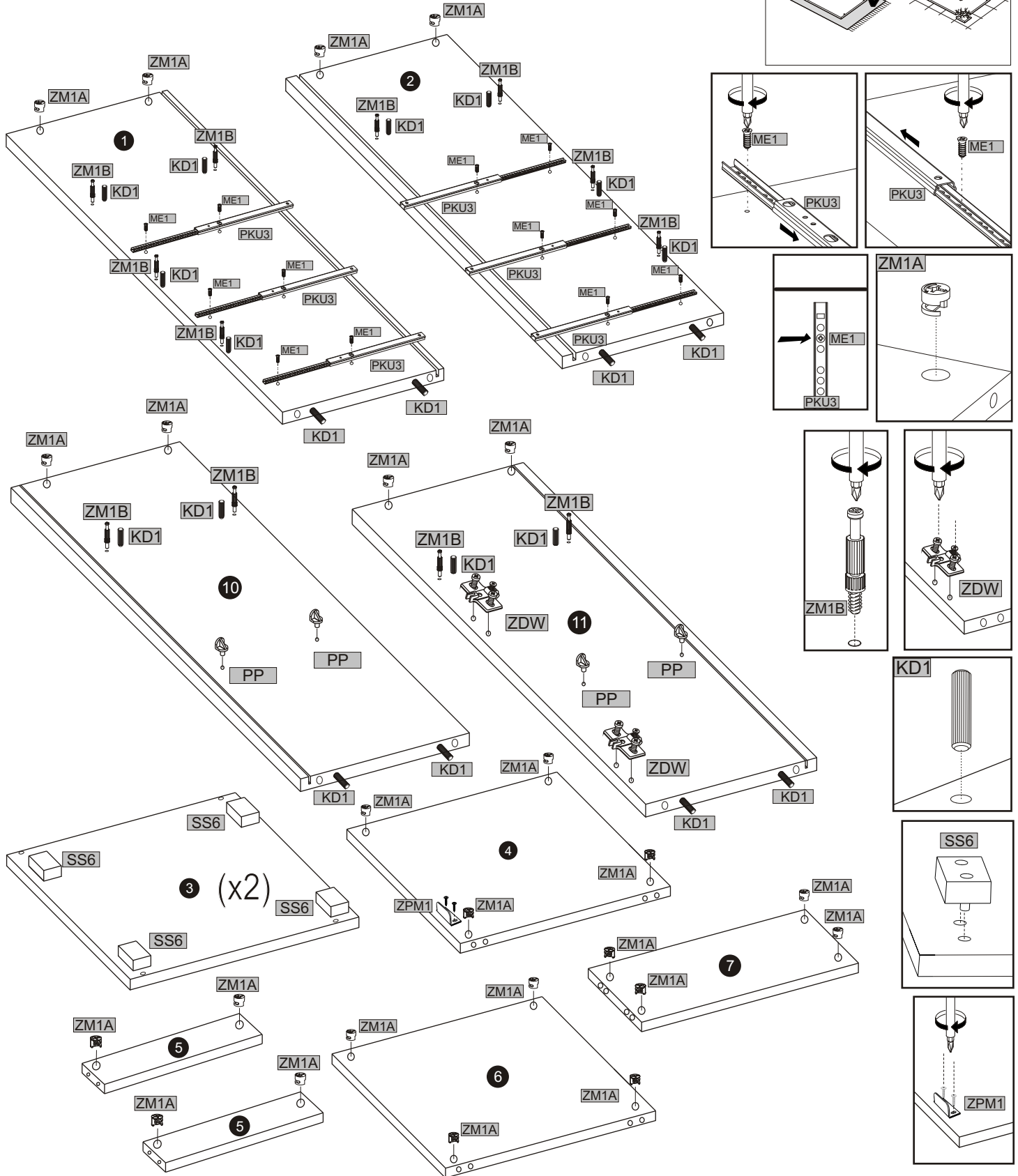

03

KK1 1	K1 6	KSK1 1	KD1 12	ZM1B 6	ZM1A 6
W1 9	ZM1 6	ZPM1 1	ZK 6		

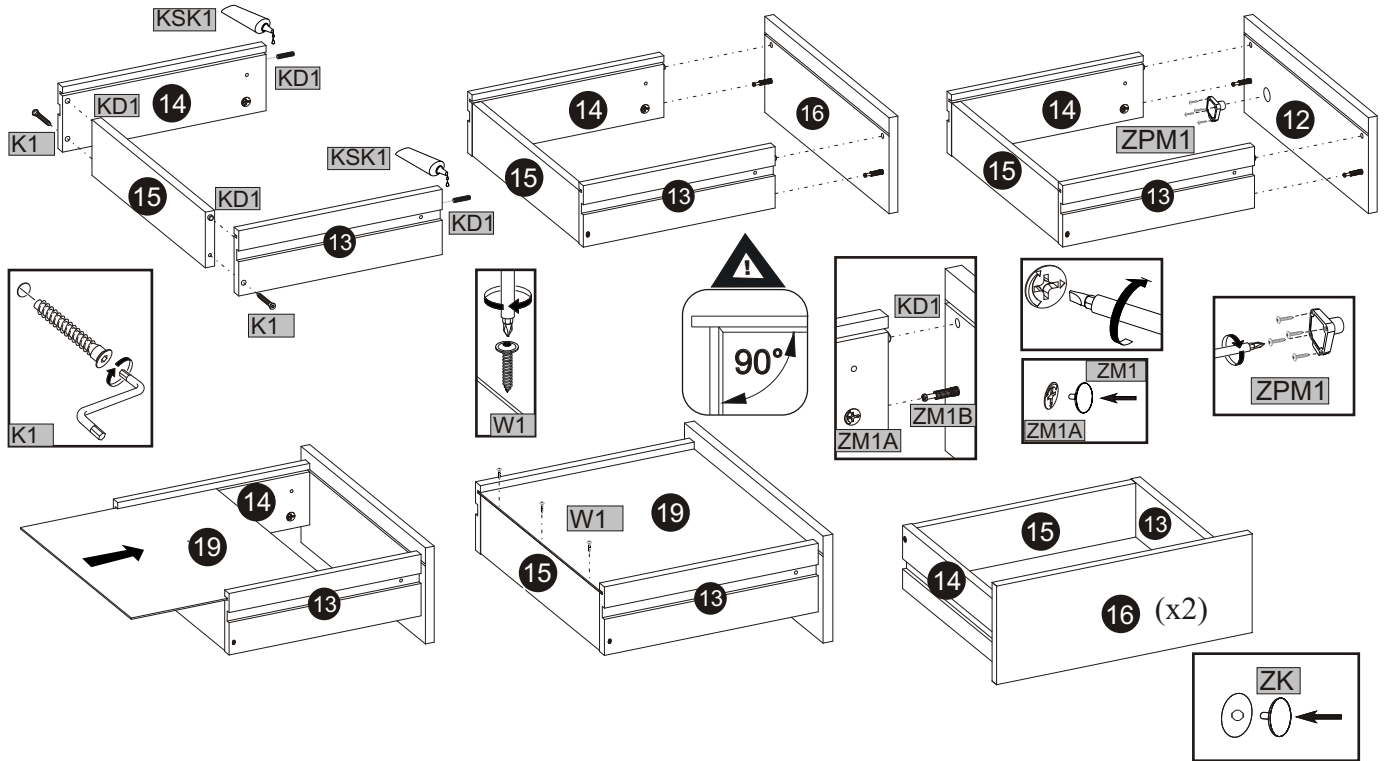

04

SR4 6	ZM1 8	ZDW1 2	W4 4

