

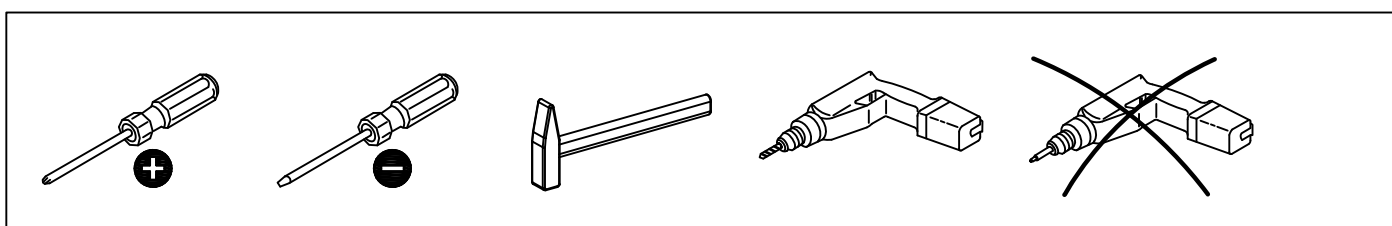

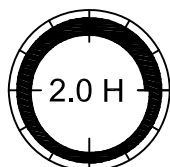

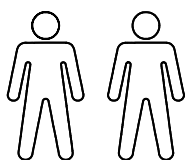

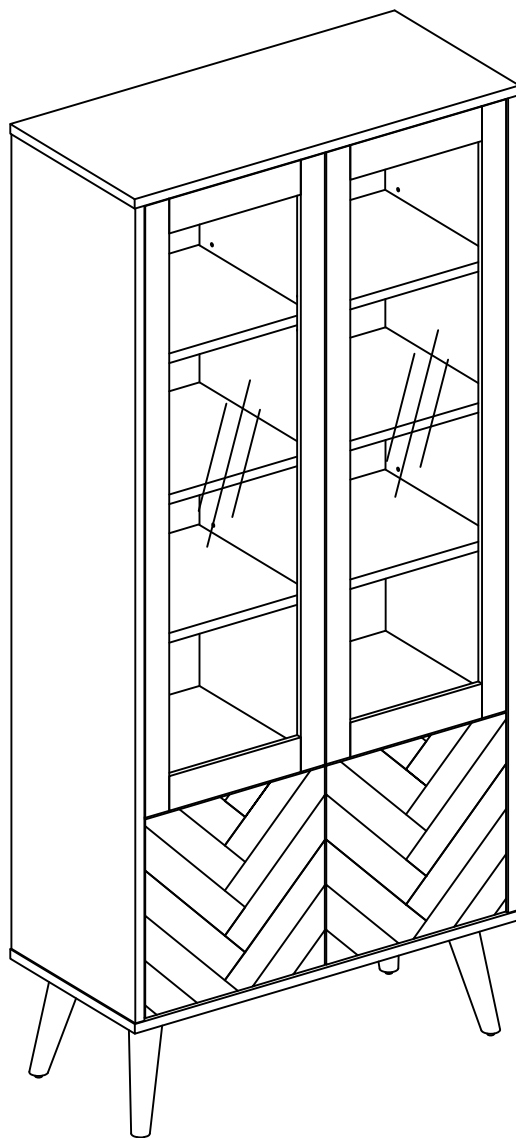

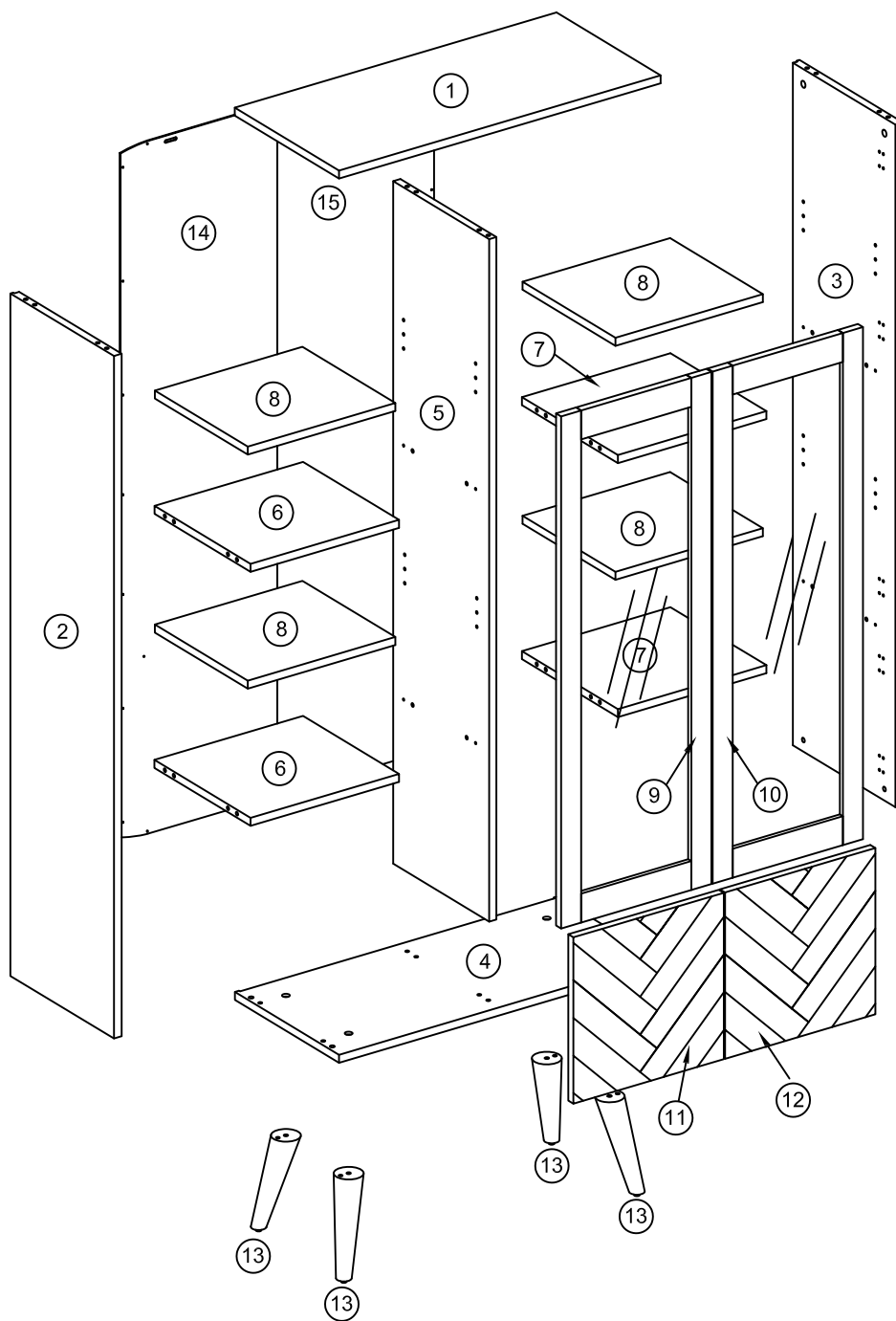

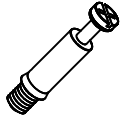

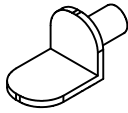
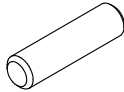

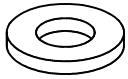
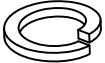

Nagano

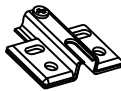

			✓
①	1	800 x 370 x 18	
②	1	800 x 370 x 18	
③	1	1534 x 368 x 18	
④	1	1534 x 368 x 18	
⑤	1	1534 x 341 x 18	
⑥	2	369.5 x 341 x 18	
⑦	2	369.5 x 341 x 18	

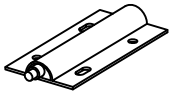
			✓
⑧	4	367 x 330 x 18	
⑨	1	1151 x 374 x 18	
⑩	1	1151 x 374 x 18	
⑪	1	374 x 374 x 18	
⑫	1	374 x 374 x 18	
⑬	4	230 x Ø60/Ø30	
⑭	1	1557 x 390 x 3	
⑮	1	1557 x 390 x 3	

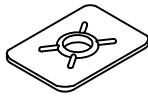

<p>A x 22</p>  <p>Ø6.5 x 43 mm</p>	<p>B x 22</p>  <p>Ø15 x 12 mm</p>	<p>C x 16</p>  <p>Ø6 mm</p>	<p>D x 32</p>  <p>Ø8 x 30 mm</p>	<p>E x 4</p>  <p>M6 x 40 mm</p>
<p>F x 4</p>  <p>Ø6/Ø16 mm</p>	<p>G x 4</p>  <p>M6</p>	<p>H x 78</p>  <p>Ø3.5 x 16 mm</p>	<p>J x 6</p>  <p>M6 x 50 mm</p>	<p>K x 10</p>  <p>Ø35 mm</p>
<p>L x 10</p> 	<p>M x 30</p>  <p>Ø3.5 x 16 mm</p>	<p>N x 1</p>  <p>4 mm</p>	<p>P x 6</p>  <p>Ø10 x 12 mm</p>	<p>Q x 4</p>  <p>90 x 45 mm</p>
<p>R x 4</p>  <p>Ø16 mm</p>	<p>S x 2</p>  <p>150 mm</p>	<p>T x 2</p>  <p>Ø4/Ø12 mm</p>	<p>U x 4</p>  <p>Ø 25 mm</p>	<p>V x 4</p>  <p>19 x 14 mm</p>

1

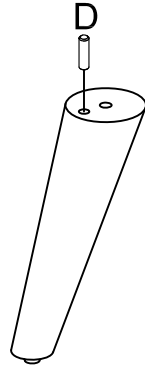
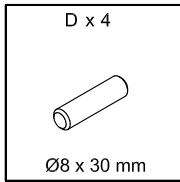



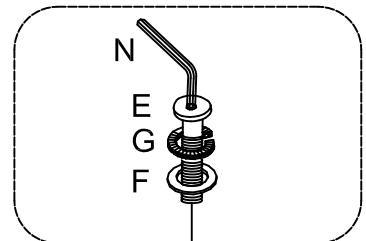
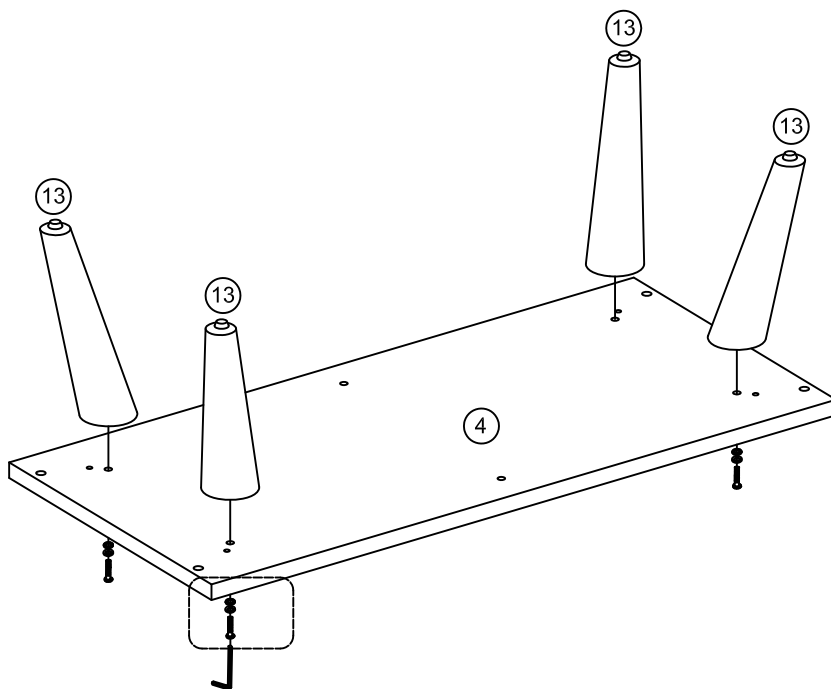
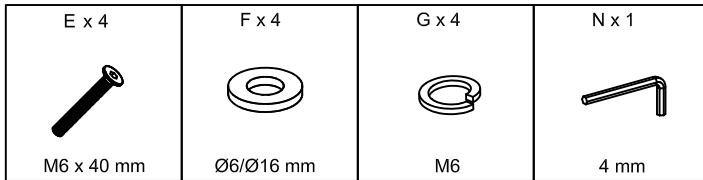

⑬ X4

2

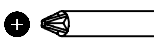

3

A x 8  Ø6.5 x 43 mm	D x 8  Ø8 x 30 mm	H x 20  Ø3.5 x 16 mm	L x 10 	
--	--	---	---	---

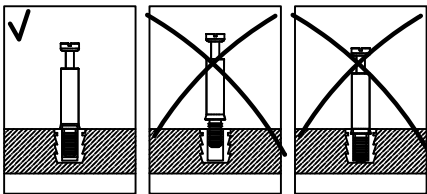
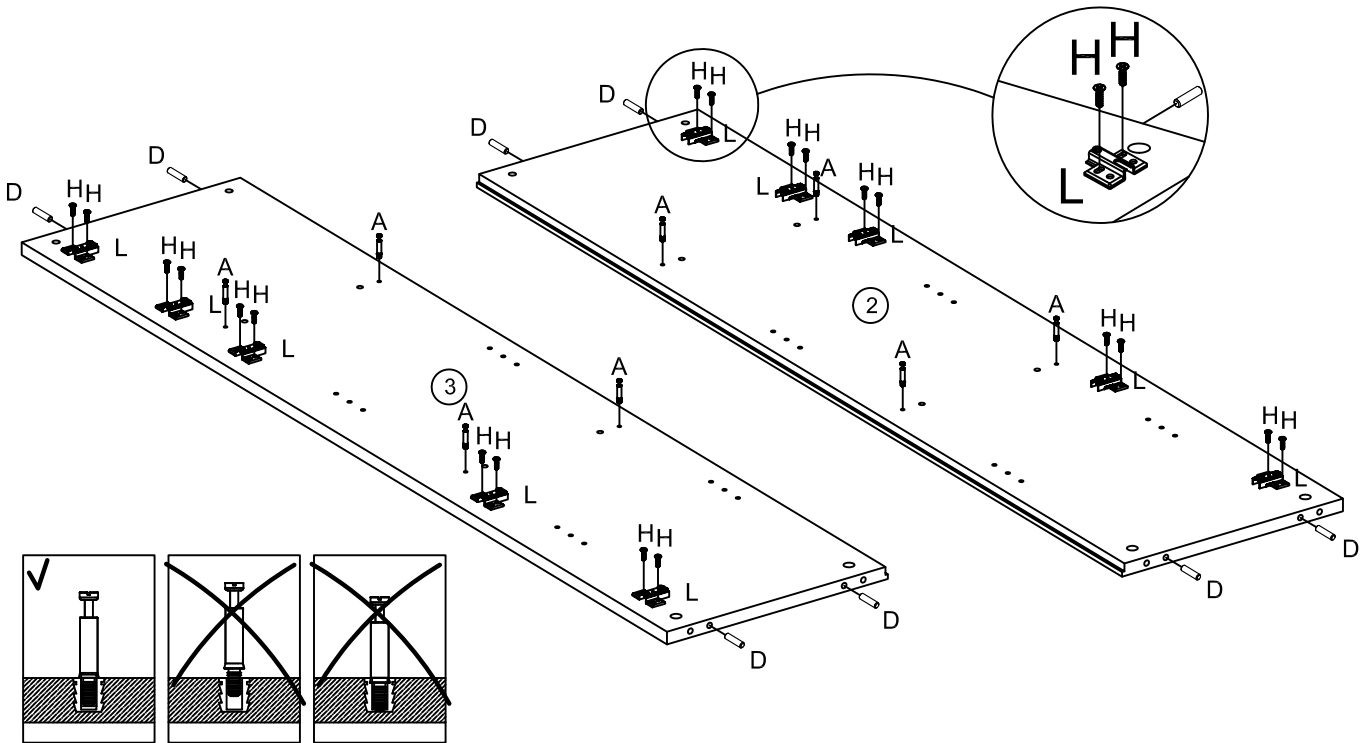

4

D x 16  Ø8 x 30 mm

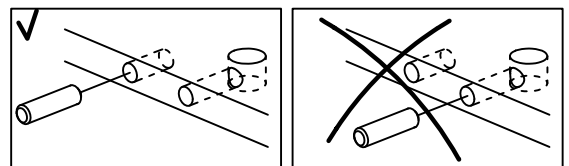
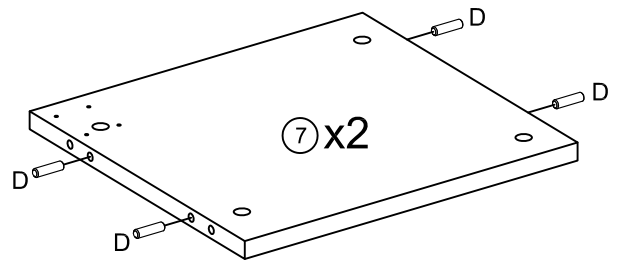
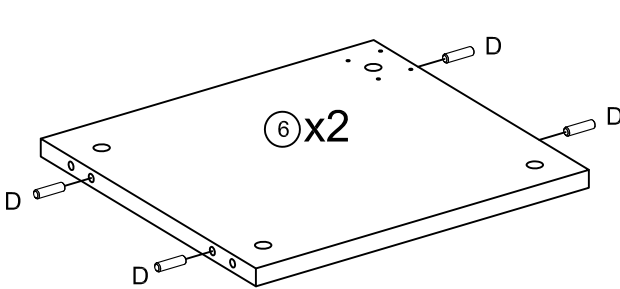

5

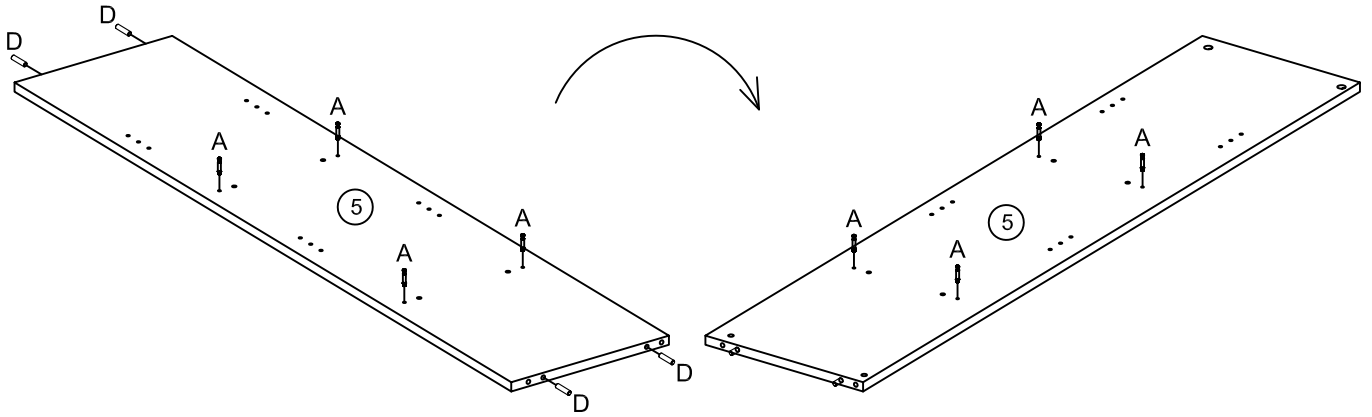
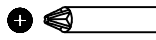
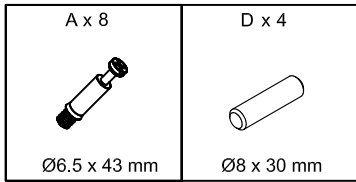

6

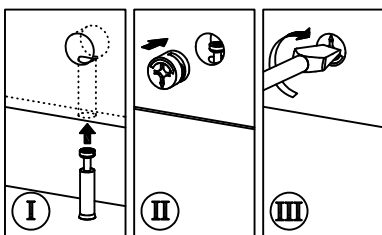
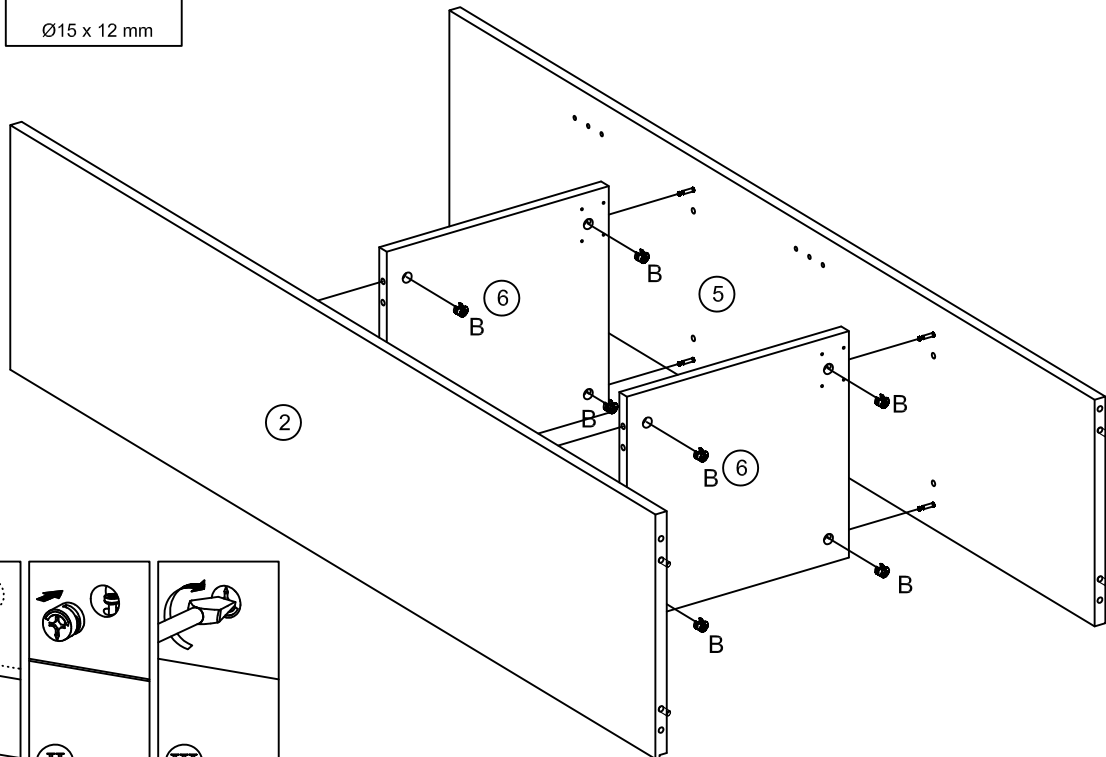
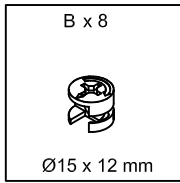



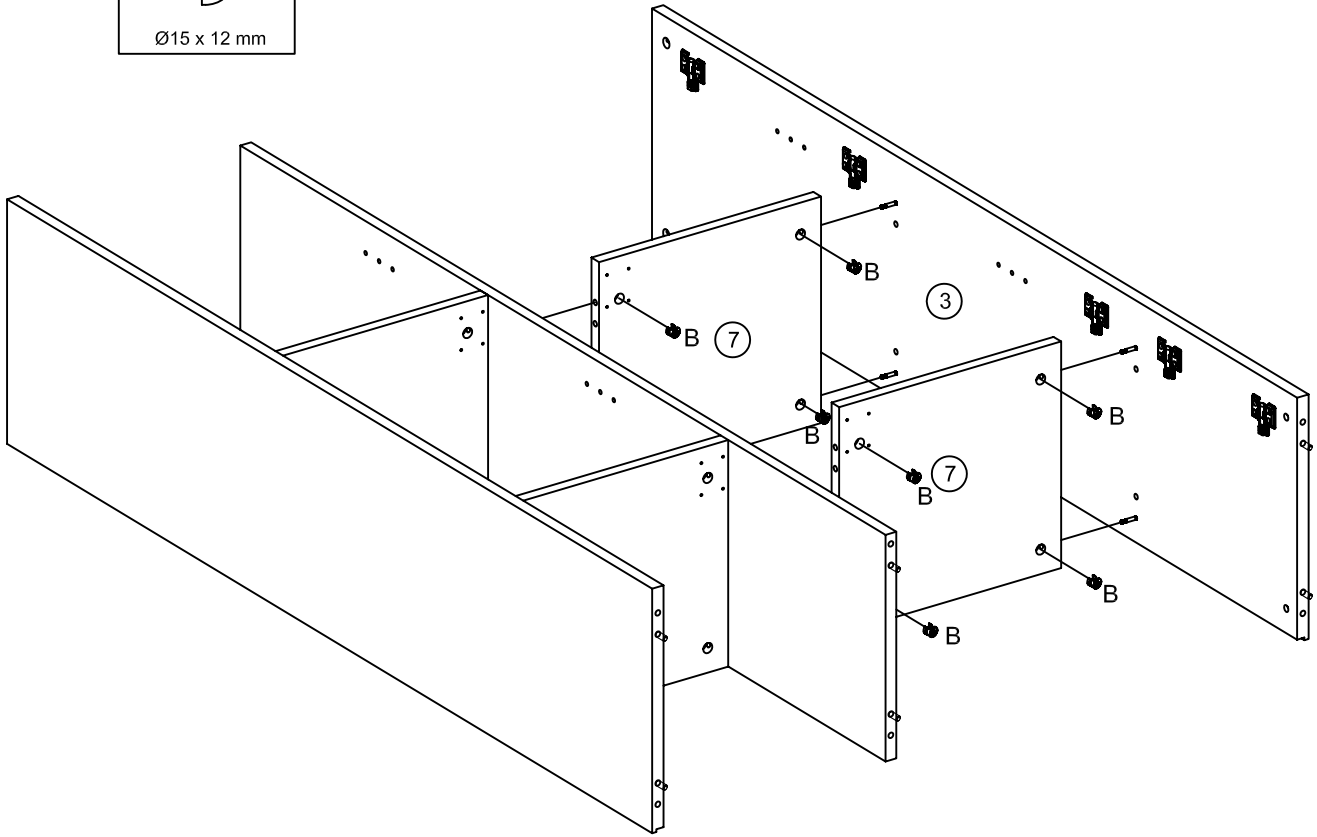
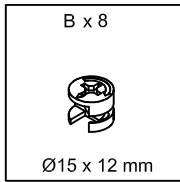

7

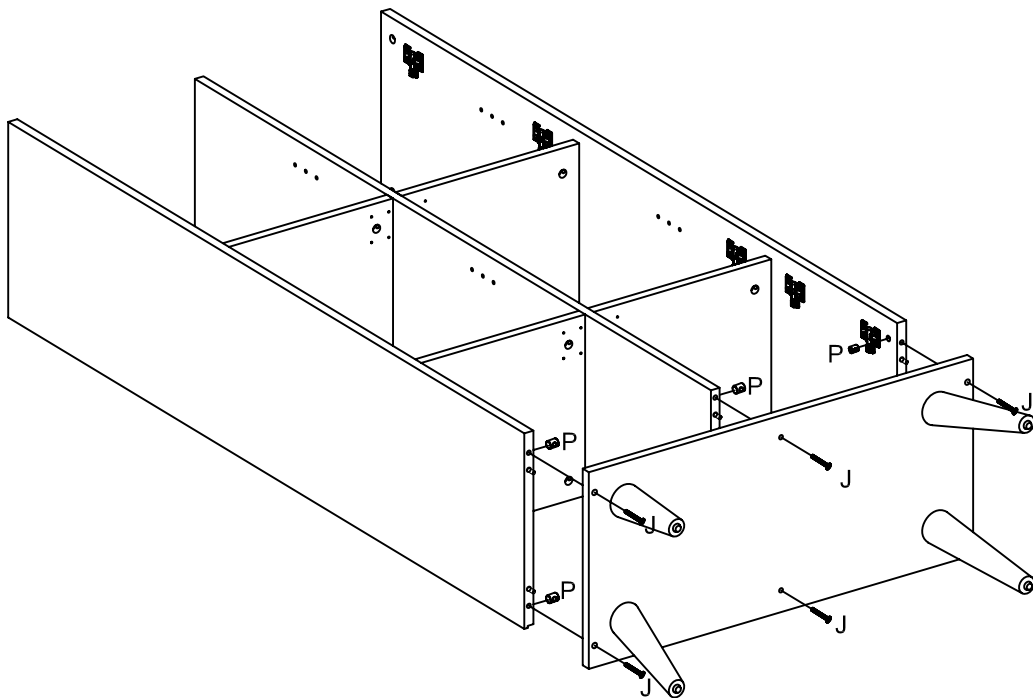
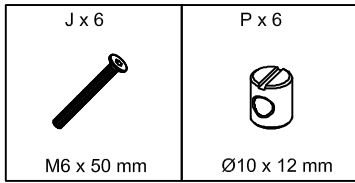

8



9

A x 6  Ø6.5 x 43 mm	H x 2  Ø3.5 x 16 mm	S x 2  150 mm	T x 2  Ø4/Ø12 mm
--	--	--	---

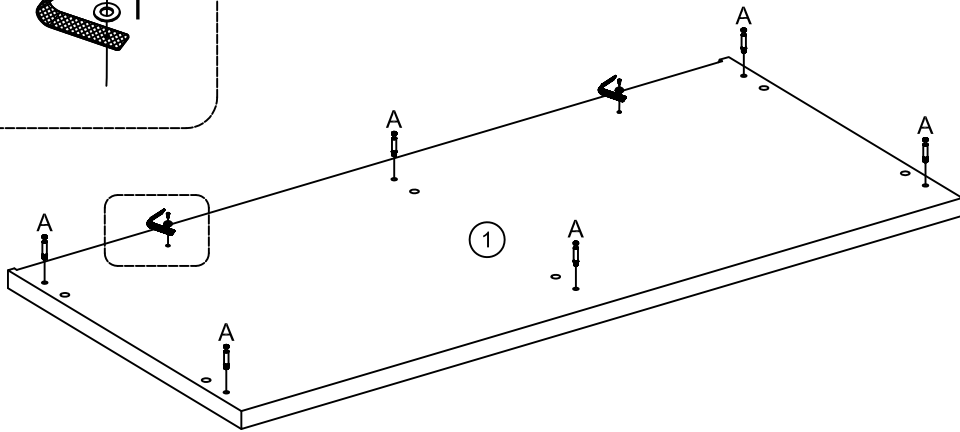
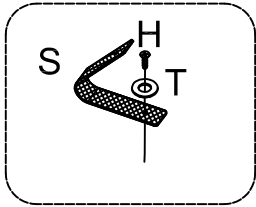

10

B x 6  Ø15 x 12 mm

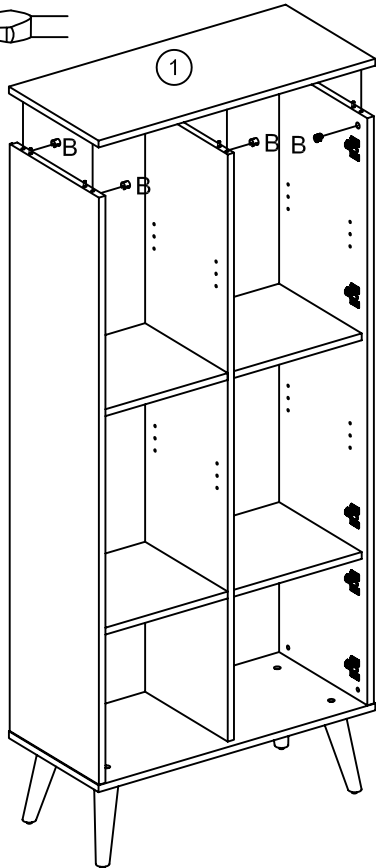

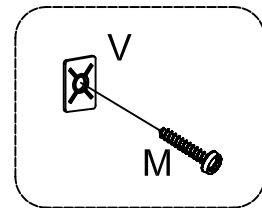
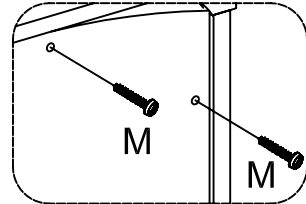
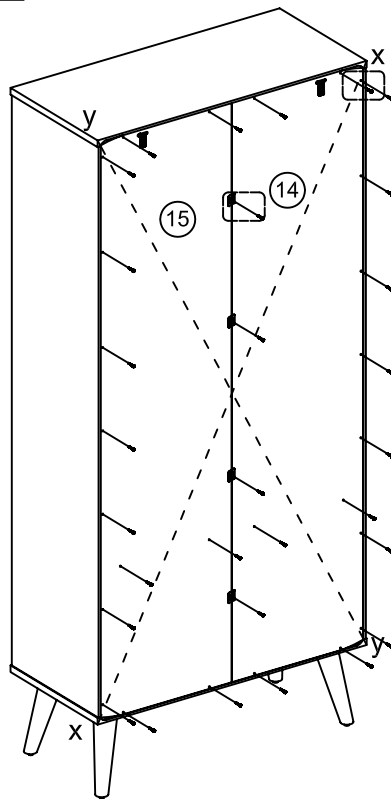
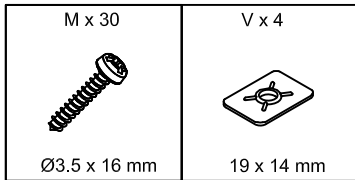

11

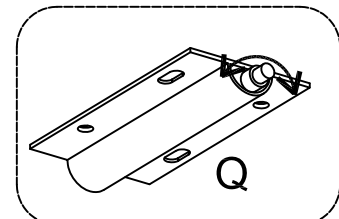
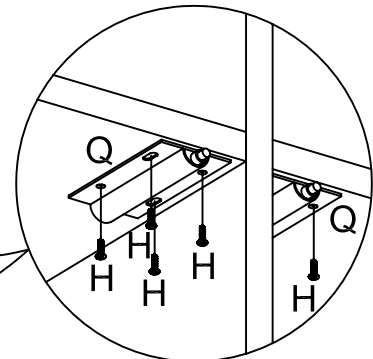
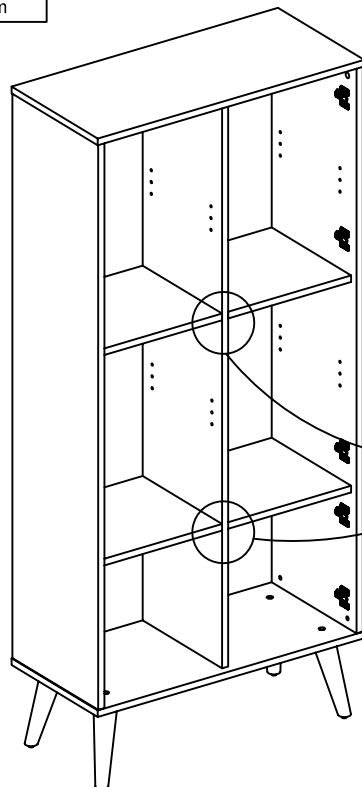
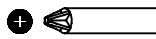
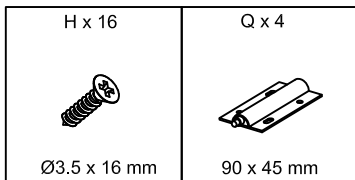

12



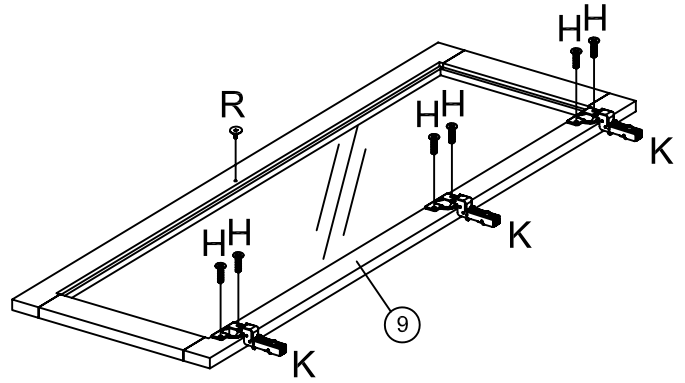
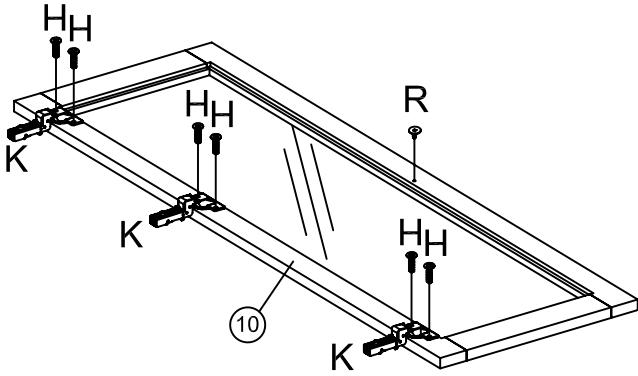

13

H x 12  Ø3.5 x 16 mm	K x 6  Ø35 mm	R x 2  Ø16 mm
---	--	--



14

H x 8  Ø3.5 x 16 mm	K x 4  Ø35 mm	R x 2  Ø16 mm
--	--	--

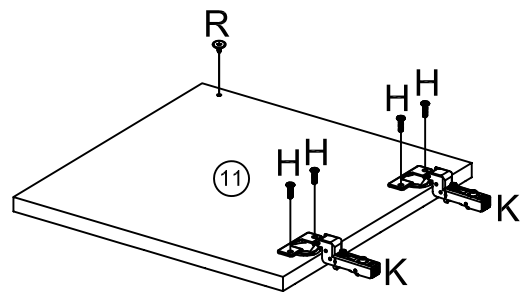
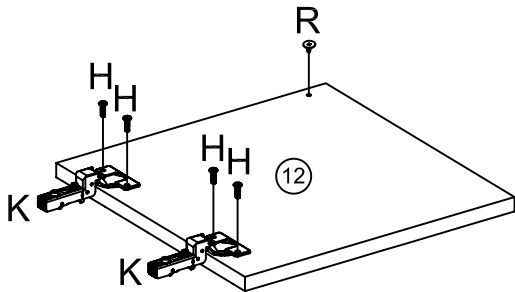
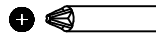

15

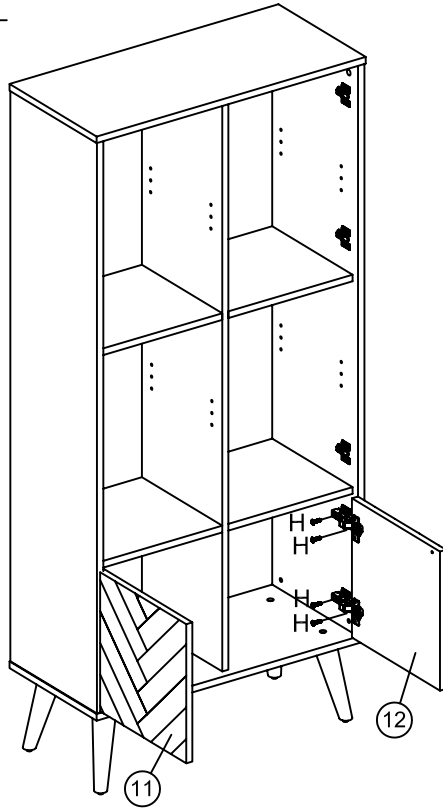
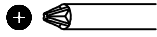
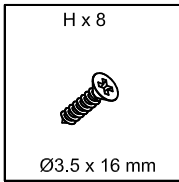

16

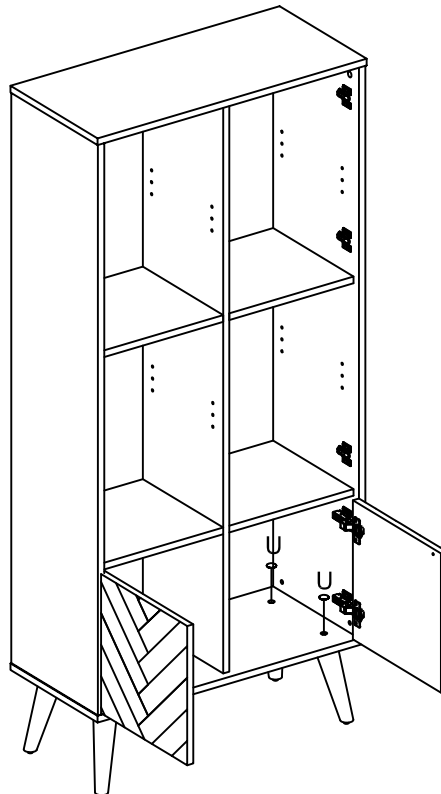
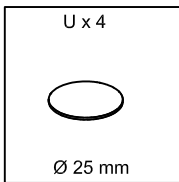

17

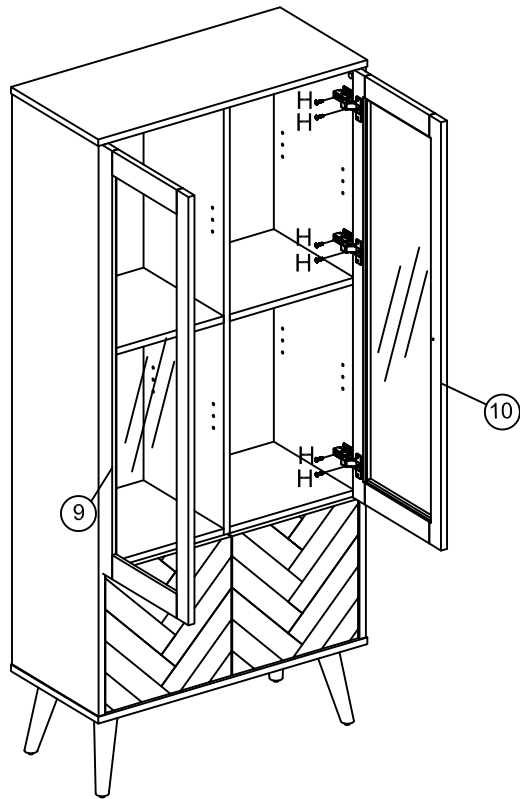
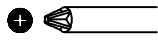
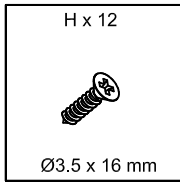

18

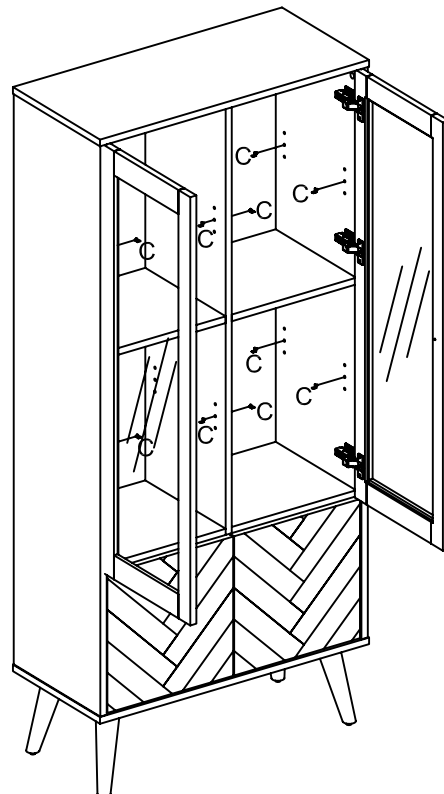
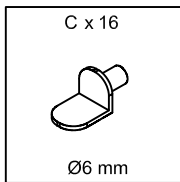

19

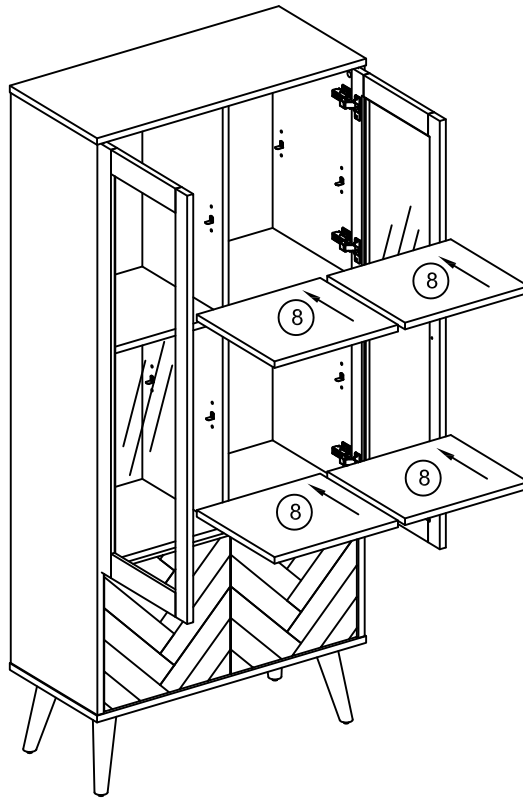

20

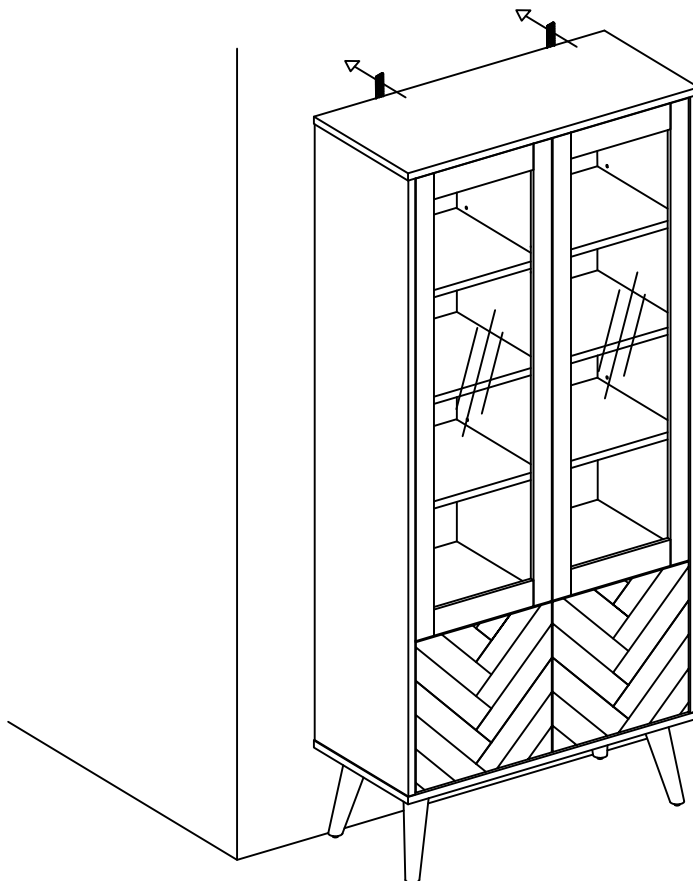

21

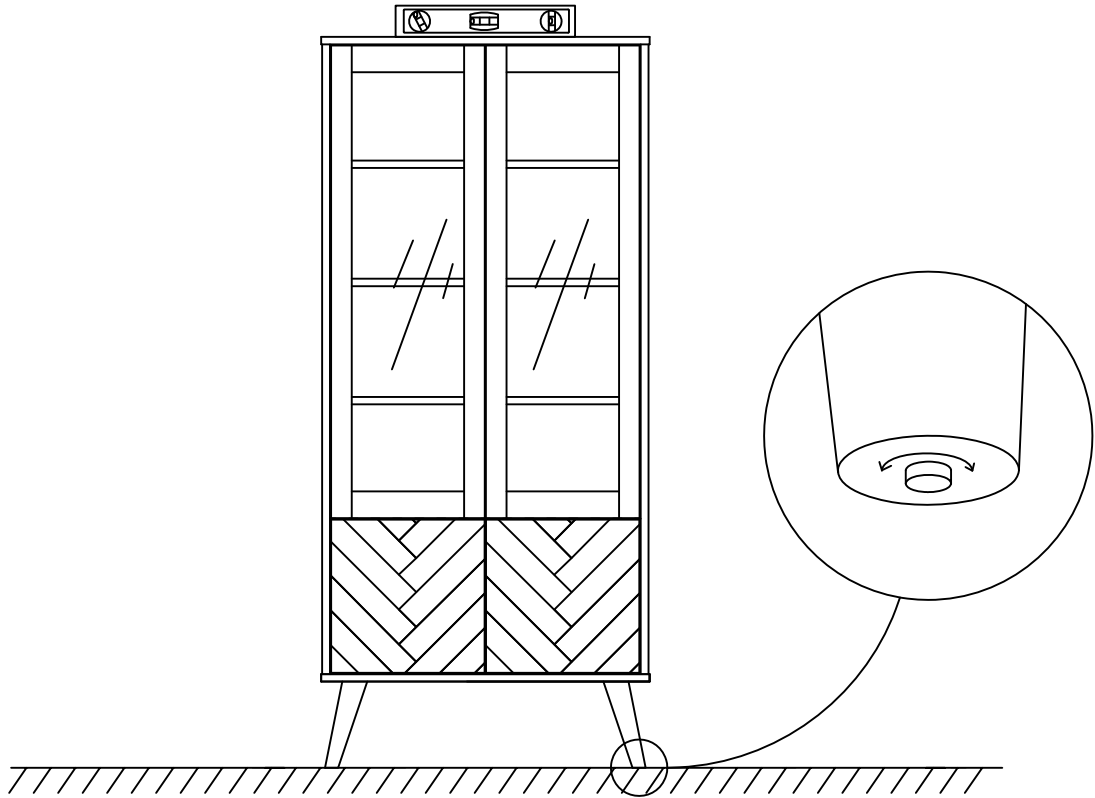
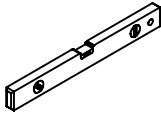

22

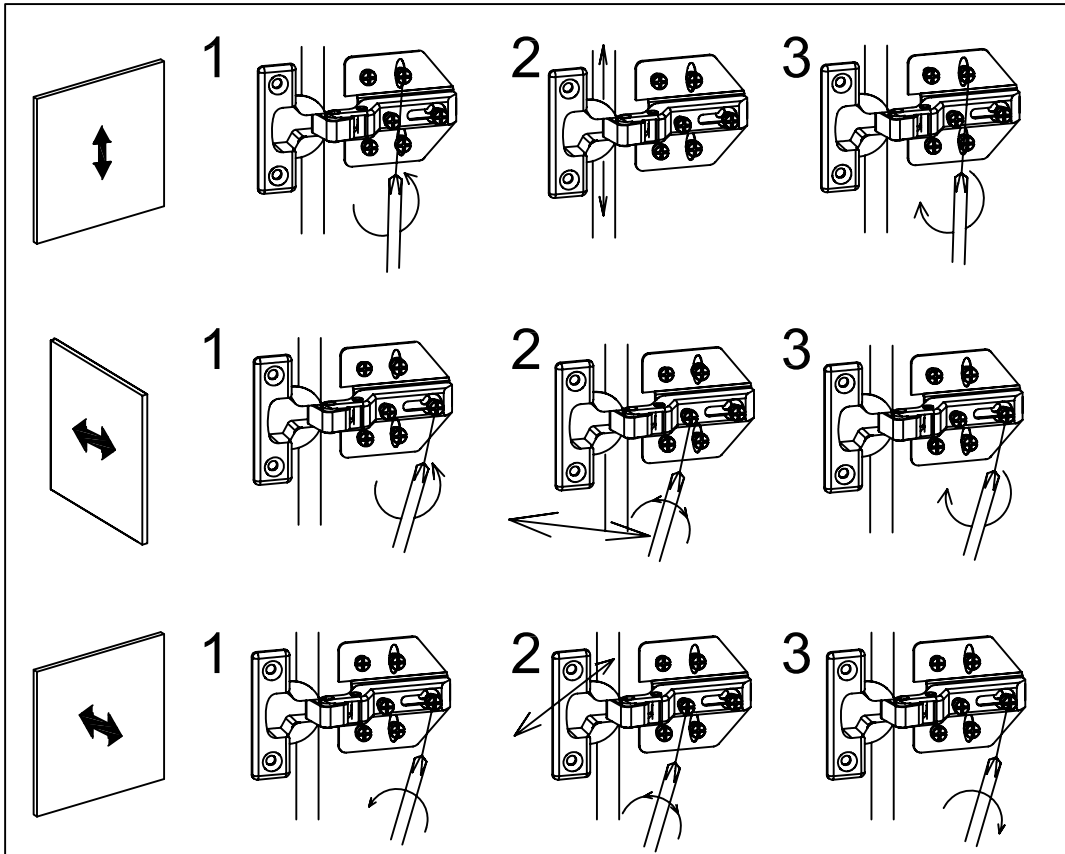

23

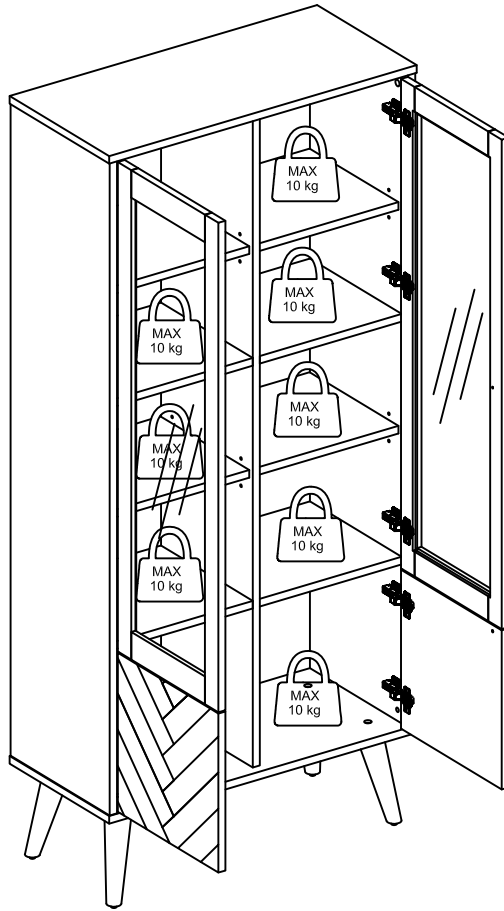

24

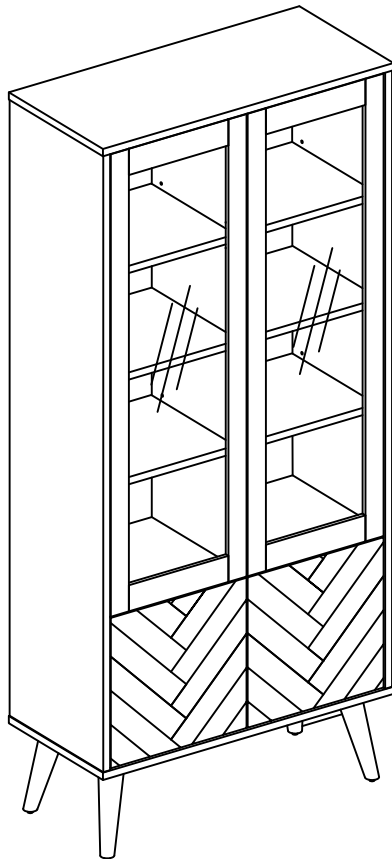



Make the Joy Last

DANSK - For information vedr. vedligeholdelse af produktet og materialer – venligst besøg:

ENGLISH - For information regarding care and maintenance of product and materials – please visit:

DEUTSCH - Informationen zur Pflege und Wartung des Produkts und der Materialien finden Sie hier:

ESPAÑOL - Para obtener información acerca del cuidado y el mantenimiento de productos y materiales, visite:

PORTUGUÊS - Para informações relativas ao cuidado e manutenção de produtos e materiais, visite:

SLOVENŠČINA - Informacije o negi in vzdrževanju izdelka ter materialov so na voljo na tem naslovu:

SVENSKA - För information om skötsel och underhåll av produkt och material - besök:

FRANÇAIS - Pour plus d'informations au sujet de l'entretien et de la maintenance du produit et des matériaux, rendez-vous à l'adresse :

NORSK - For informasjon om pleie og vedlikehold av produkt og materialer, se:

SUOMI - Lisätietoja tuotteen ja materiaalien huollosta ja kunnossapidosta on osoitteessa

NEDERLANDS - Ga voor meer informatie over verzorging en onderhoud van het product en de materialen naar:

ITALIANO - Per informazioni riguardanti la cura e la manutenzione di prodotti e materiali, visitare:

ČEŠTINA - Další informace ohledně údržby a péče o výrobek a povrchové materiály naleznete na webové stránce:

POLSKI - Aby uzyskać informacje na temat pielęgnacji i konserwacji produktu i materiałów, odwiedź:

SLOVENSKÍ - Další informace o údržbě a starostlivosti o produkt a povrchové materiály najdete na webové lokalite:

MAGYAR - A termékek és anyagok ápolására és karbantartására vonatkozó információkért kérjük, látogasson el a következő oldalra:

TÜRKÇE - Ürün ve malzemelerin temizlik ve bakımı hakkında bilgi almak için - lütfen ziyaret edin:

РУССКИЙ - Информация по уходу за изделием и материалами на сайте:

ROMÂNĂ - Pentru informații privind îngrijirea și întreținerea produsului și a materialelor, vă rugăm să vizitați:

INDONESIAN – Untuk informasi lebih lanjut mengenai petunjuk perawatan barang dan material – harap kunjungi:

makejoylast.com

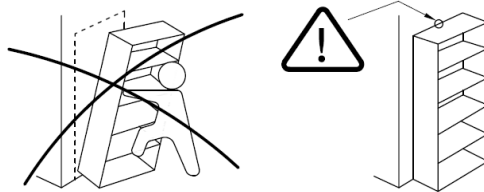

DANSK – VIGTIG INFORMATION: Læs hele manualen grundigt igennem før samling og/eller brug af dette produkt. Følg manualen nøje, og opbevar den til senere brug.

ADVARSEL! Skrue som følger med væltesikringen, er kun til at fæstne væltesikringen i møblet. Enkelte produkter skal forankres direkte i væg (uden beslag) og her vil der ikke medfølge nogen skrue. Du skal derfor supplere med en skrue eller et beslag som passer til det materiale din væg er lavet af. Hvis du er usikker så kontakt din lokale fagmand.

ENGLISH – IMPORTANT INFORMATION: Please read the entire manual carefully before starting to assemble and/or using this product. Follow the manual thoroughly and keep it for further reference.

WARNING! The screw supplied together with the anti-topple bracket is to be used only for fixing the anti-topple bracket to the furniture. Some products must be fixed directly to the wall (without bracket) and for these no screws are included. In addition to this, you will need to choose a screw or fitting which is suitable for securing the bracket to the kind of walls you have. If you are unsure about what type of screw to use contact your local hardware store.

DEUTSCH – WICHTIGE INFORMATION: Bitte die komplette Montageanleitung sorgfältig durchlesen bevor Sie mit der Montage und/oder dem Gebrauch des Produktes anfangen. Folgen Sie der Anleitung und bewahren Sie diese gut auf.

WARNUNG! Die dem Kippschutz beigelegten Schrauben sind ausschließlich für die Befestigung des Kippschutzes am Möbelstück vorgesehen. Einige Produkte müssen direkt an der Wand befestigt werden (ohne Halterungen) und es wird dafür keine Schraube mitgeliefert. Für die Befestigung des Kippschutzes an der Wand benötigen Sie zusätzlich Schrauben oder Beschläge, die zur Beschaffenheit der Wand passen. Falls Sie nicht sicher sind, welche Art von Schrauben geeignet sind, wenden Sie sich bitte an den Fachhandel.

ESPAÑOL – IMPORTANTE INFORMACIÓN: Por favor lea atentamente las instrucciones completas antes de empezar a montar o usar este producto. Siga las instrucciones del manual y guárdelas para futuras consultas.

ADVERTENCIA! El tornillo suministrado junto con el soporte antivuelco se debe utilizar solo para fijar el soporte antivuelco de los muebles. Algunos productos se deben anclar directamente en la pared (sin soportes) y para estos no se incluirán tornillos. Además, se tendrá que elegir un tornillo o accesorio que sea adecuado para asegurar el soporte correcto para el tipo de paredes en donde se fijara el mueble. Si no está seguro sobre qué tipo de tornillo usar, póngase en contacto con su ferretería local.

PORTUGUÊS – INFORMAÇÃO IMPORTANTE: Por favor leia atentamente o manual de montagem completo antes de começar a montar ou usar este produto. Siga as instruções do manual e guarde-o para futura consulta.

AVISO! O parafuso fornecido com o dispositivo anti-queda deve ser usado exclusivamente para fixar o dispositivo ao móvel. Alguns produtos devem ser pendurados diretamente na parede (sem suporte) e nestes casos, os parafusos não são fornecidos de fábrica. Para fixar os móveis na parede, escolha um parafuso ou dispositivo de fixação que melhor se adapte às paredes da sua casa. Em caso de dúvida, entre em contato com a loja de ferragens mais próxima.

SLOVENSKO – POMEMBNE INFORMACIJE: Pred montažo oz. uporabo izdelka pozorno preberite celotna navodila. Navodila dosledno upoštevajte in jih shranite, saj jih boste morda še potrebovali.

OPOZORILO! Vijak, priložen konzoli za zaščito pred prevrnitvijo, lahko uporabite le za pritrditev nosilca za zaščito pred prevrnitvijo na pohoštvo. Nekateri izdelki morajo biti pritrjeni neposredno na steno (brez nosilca), zato nimajo priloženih nobenih vijakov. Poleg tega boste morali izbrati vijak ali pritrdilni element, ki je primeren za pritrditev nosilca na vrsto sten, ki jih imate. Če ne veste, katero vrsto vijakov uporabiti, se obrnite na lokalno trgovino z opremo za dom.

SVENSKA – VIKTIG INFORMATION: Läs hela monteringsanvisningen noggrant innan montering och/eller användning av produkten. Följ anvisningarna noggrant och spara monteringsanvisningen för framtida referens.

WARNING! Observera att skruven som medföljer tippskyddet endast är avsedd för att fästa tippskyddet i möbelen. Vissa produkter måste fästas direkt i väggen (utan beslag) och det medföljer inte skruvar till detta. Komplettera därför med en skruv eller ett fästbeslag som passar materialet i din vägg. Är du osäker på vilken skruv som skall användas bör du kontakta din lokala fackhandel.

FRANÇAIS - INFORMATION IMPORTANT: Veuillez lire attentivement l'intégralité du manuel avant de commencer à assembler et / ou à utiliser ce produit. Suivez attentivement le manuel et conservez-le pour référence ultérieure.

ATTENTION ! La vis fournie avec le dispositif anti-bascule est destinée à être fixée sur le meuble. Certains produits sont à fixer directement sur le mur, mais sont livrés sans visserie. Pour les fixer, il faut utiliser une vis adaptée au support mural. En cas de doute, contactez un magasin de bricolage.

NORSK – VIKTIG INFORMASJON: Les hele håndboken nøye før du begynner å sette sammen og/eller bruke dette produktet. Følg bruksanvisningen og oppbevar den for nærmere referanse.

ADVARSEL! Legg merke til at skruen som følger med tippetbeskyttelsen kun skal brukes for å feste tippetbeskyttelsen i møbelet. Enkelte produkter må festes direkte i vegg (uten beslag), og her vil det ikke følge med skruer. Kompletter derfor med en skrue eller et festsbeslag tilpasset materialet i veggen din. Er du usikker, ta kontakt med din lokale fagforhandler.

SUOMI – TÄRKEITÄ TIETOJA: Lue käyttöohjeet kokonaan ennen tämän tuotteen kokoamista ja/tai käyttöä. Noudata käyttöohjeita tarkasti ja säilytä ne myöhempää tarvetta varten.

VAROITUS! Ruuvia, joka on toimitettu kaatumisen estävien kannatinten kanssa, on käytettävä vain kaatumisen estävän kannattimen kiinnittämiseen huonekaluun. Jotkin tuotteet pitää kiinnittää suoraan seinään (ilman kannatinta), eikä ruuveja ole näiden kohdalla mukana. Tämän lisäksi sinun on valittava ruuvi tai kiinnitin, joka sopii kannattimen kiinnittämiseen sellaisiin seiniin, joita sinulla on. Jos olet epävarma käytettävän ruuvien tyypistä, ota yhteys paikalliseen rautakauppaasi.

NEDERLANDS – BELANGRIJKE INFORMATIE: Lees de gehele handleiding eerst zorgvuldig, alvorens het product te monteren en/of gebruiken. Volgt de montage-handleiding nauwkeurig, en bewaar deze ook voor later.

WAARSCHUWING! De schroeven die bij de wandbevestiging zitten, zijn uitsluitend bedoeld om de wandbevestiging aan het meubel te bevestigen. Bepaalde artikelen moeten direct aan de wand bevestigd worden (zonder bevestigingsbeugel o.i.d.) en daarvoor worden geen schroeven meegeleverd. Completeer de wandbevestiging met een schroef of bevestigingsbeslag dat geschikt is voor het materiaal van de wand. Neem bij twijfel contact op met de ijzerhandel of bouwmarkt.

ITALIANO - INFORMAZIONI IMPORTANTI: Prima di assemblare e utilizzare questo prodotto, leggere attentamente le istruzioni di montaggio. Conservare attentamente questo libretto di istruzioni per riferimenti futuri.

AVVERTENZA! La vite fornita con il dispositivo dispositivo di ribaltamento deve essere utilizzata solo per fissare questo dispositivo ai mobili. Alcuni prodotti devono essere fissati direttamente alla parete (senza staffa) e per questi non sono invluse viti. Per attaccare la mobilia alla parete, scegliere una vite o un dispositivo di fissaggio che meglio si adatta alle pareti della sua casa. In caso di dubbio, contattare il negozio di ferramenta più vicino.

ČESKY - DŮLEŽITÉ INFORMANCE: Přečtěte si prosím pozorně celý manuál před samotnou montáží a použitím výrobku. Následujte manuál důkladně a odložte si jej pro budoucí referenci.

VAROVÁNÍ! Šroub dodávaný spolu s konzolou proti převrnutí je určen k použití pouze na upevnění konzoly proti převrnutí k nábytku. Některé výrobky se musí uchopit přímo ke stěně (bez konzoly) a u těchto výrobků nejsou šrouby součástí balení. Navíc si budete muset vybrat šroub nebo uchycení vhodné pro upevnění konzoly k příslušnému typu stěny.

POLSKI - WAŻNE INFORMACJE: Przeczytaj uważnie całą instrukcję przed instalacją i użyciem produktu. Postępuj zgodnie z instrukcją i zachowaj ją na przyszłość.

OSTRZEŻENIE! Śruba dołączona do wspornika zabezpieczającego przed wywróceniem się mebla służy wyłącznie do mocowania tego wspornika do mebla. Niektóre produkty musi być mocowane bezpośrednio do ściany (bez wspornika) i do nich śruby nie są dołączane. Ponadto niezbędny będzie wybór takich śrub lub mocowań, które nadają się do przymocowania wspornika do rodzaju posiadanych ścian. W przypadku wątpliwości dotyczących rodzaju śrub prosimy o kontakt z miejscowym sklepem z artykułami przemysłowymi.

SLOVENSKY – DÔLEŽITÉ INFORMÁCIE: Prečítajte si prosím pozorne celý manuál pred samotnou montážou a použitím výrobku. Nasledujte manuál dôkladne a odložte si ho pre budúcu referenciu.

VAROVANIE! Skrutka dodávaná spolu s konzolou chrániacou pred prevrátením sa smie používať len na upevňovanie tejto konzoly k nábytku. Niektoré produkty sa musia pripevniť priamo na stenu (bez konzoly), v takomto prípade sa nedodávajú žiadne skrutky. Okrem toho bude potrebné vybrať skrutku alebo úchytku vhodnú na zaistenie konzoly na typ steny, ktorý máte. Ak máte pochybnosti o hľadom typu skrutky, ktorý je potrebný použiť, obráťte sa na svoje miestne železiarstvo.

MAGYAR - FONTOS INFORMÁCIÓK: A termék összeszerelésének vagy használatának megkezdése előtt figyelmesen olvassa el a teljes útmutatót. Őrizze meg az útmutatót, és a továbbiakban is kövesse a benne foglaltakat.

FIGYELEM! A rögzítőkonzolhoz mellékelt csavar csak a rögzítőkonzol bútorhoz történő rögzítéséhez használható. Egyes termékeket közvetlenül a falhoz kell rögzíteni (konzol nélkül) és ezekhez csavart nem mellékelünk. Továbbá ki kell választani a fal típusának megfelelő csavart vagy szerelvényt a konzol felszereléséhez. Ha nem biztos benne, hogy milyen típusú csavart használjon, érdeklődjön a helyi barkácsboltban.

TÜRKÇE – ÖNEMLİ BİLGİLER: Bu ürünün montajını yapmaya başlamadan ve/veya ürünü kullanmadan önce lütfen kılavuzun tamamını dikkatlice okuyun. Kılavuzu adim adim izleyin ve daha sonra başvurmak üzere saklayın.

UYARI! Devrilmeye karşı koruyucu braket ile birlikte verilen vida yalnızca devrilmeye karşı koruyucu braketi mobilyaya sabitlemek için kullanılır. Bazı ürünler doğrudan duvara sabitlenmeli (braket olmadan) ve bunlar için vida gerekli değildir. Buna ek olarak, braketi duvar tipinize sabitlemek için uygun bir vida veya bağlantı parçası seçmeniz gerekecektir. Hangi tip vida kullanılacağı konusunda emin değilseniz, nalburunuza danışın.

РУССКИЙ — ВАЖНАЯ ИНФОРМАЦИЯ! Прежде чем приступить к сборке или использованию товара, прочитайте внимательно это руководство. Следуйте всем инструкциям этого руководства и сохраните его на будущее для справки.

ВНИМАНИЕ! Шурупы, поставляемые с кронштейнами против опрокидывания, предназначены только для монтажа кронштейнов против опрокидывания к мебели. Некоторые товары крепятся непосредственно к стене (без кронштейнов). Для таких товаров шурупы не прилагаются. Кроме того, вам будет необходимо подобрать подходящий шуруп или крепление для монтажа кронштейна к стене в зависимости от материала, из которого она изготовлена. Если вы сомневаетесь в выборе шурупов, проконсультируйтесь с продавцом в строительном или хозяйственном магазине.

ROMÂNĂ – INFORMAȚII IMPORTANTE: Citiți cu atenție întregul manual înainte de a începe să montați și/sau să utilizați acest produs. Urmați îndeaproape instrucțiunile din manual și păstrați-l pentru consultare ulterioară.

ATENȚIE! Șurubul livrat împreună cu suportul anti-răsturnare trebuie folosit doar pentru fixarea suportului anti-răsturnare pe mobilă. Unele produse trebuie fixate direct pe perete (fără suport), iar pentru acestea nu sunt incluse șuruburi. Mai mult decât atât, veți avea nevoie să alegeți un șurub sau o garnitură care să fie adecvate pentru fixarea suportului pe tipul de perete pe care îl aveți. Dacă nu sunteți siguri ce tip de șurub să folosiți, contactați magazinul local de materiale de construcții.