



























- B1**  ϕ 8x28 x56
- T1**  x24
- M1**  x16
- M12**  x8
- C2**  ϕ 20 x16
- W1**  x8
- B4**  x16
- J23**  x20
- F1**  x10
- P2**  3x16 x10
- F10**  x6
- P17**  4x20 x6
- L21**  x10
- P13**  3,5x13 x40

- Z25**  x4
- S8**  4x13 x12
- Z2**  KR8 x2
- D3**  x2
- E1**  6,3x13 x4
- U90**  x7
- P5**  4x30 x14
- R1**  246 x8
- E4**  6,0x8 x16
- A1**  M4x9 x8
- J11**  x1
- T17**  ϕ 8x50 5x60 x1
- P13**  3,5x13 x2

Nr	Ausmaß			St	Colli
1	838	350	15	2	2
2	300	100	12	4	2
3	300	100	12	4	2
4	346	183	15	4	1
5	744	346	15	1	1
6	838	329	15	1	1
7	838	329	15	1	2
8	387	329	15	1	2
9	736	329	15	1	2
10	750	60	15	2	1
11	1520	60	15	2	2
12	301	100	12	4	2
13	1520	350	15	1	2
14	1520	350	15	1	2
15	312	299	2	4	2
16	852	400	2	2	1
17	852	349	2	1	1
18	852	349	2	1	1
19	744	346	15	2	1

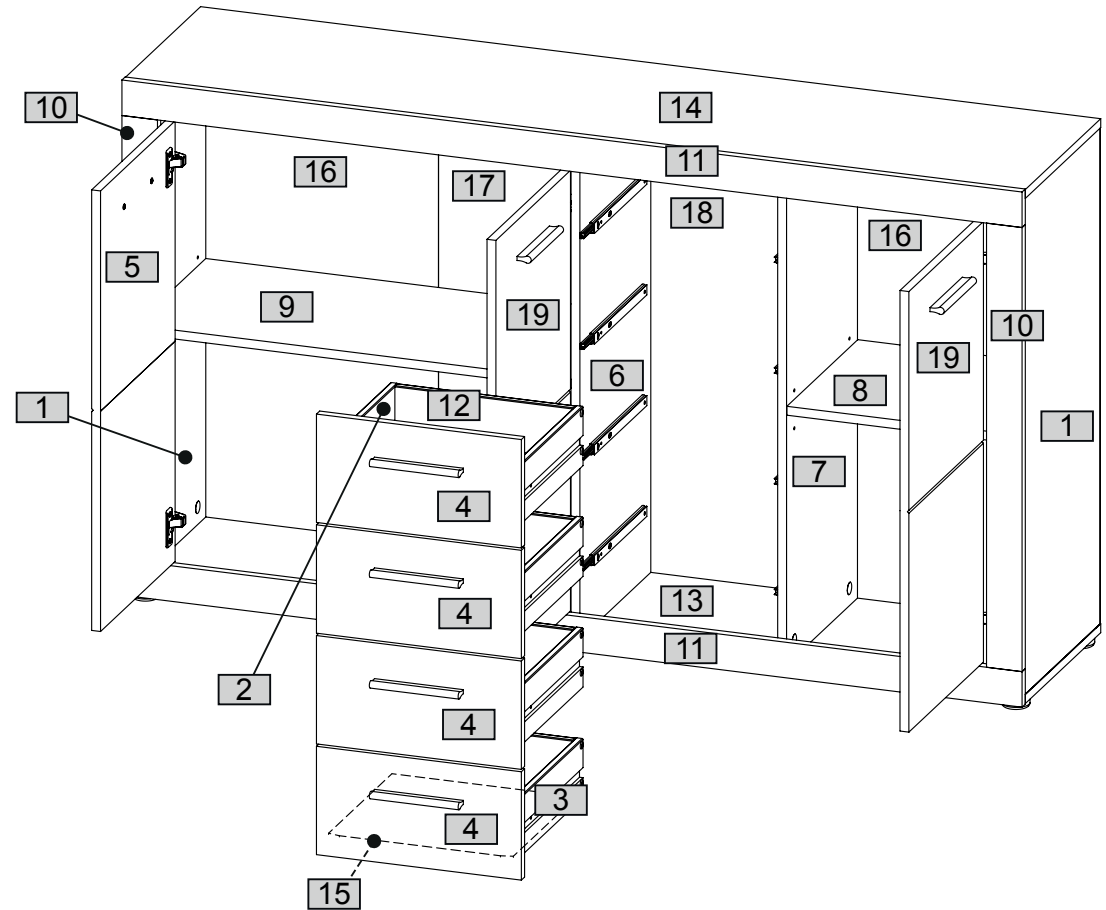

0 10 20 30 40 50 60 70 80 90 100 110 120 130 140 150 160 170 180 190 200



1

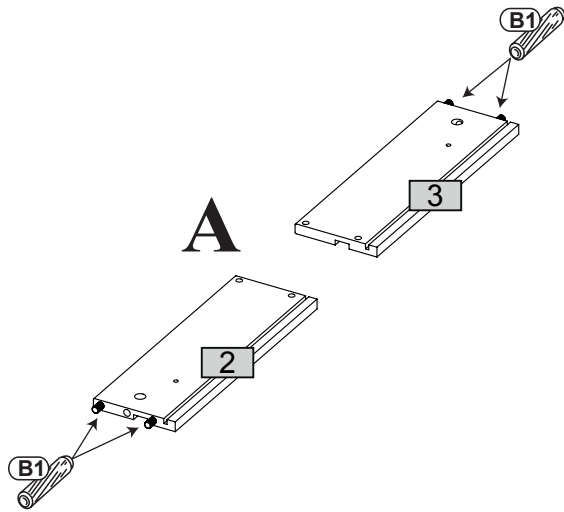
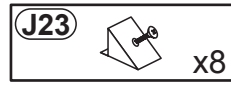
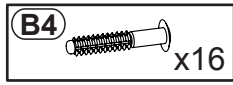
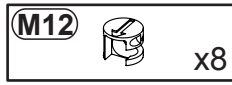
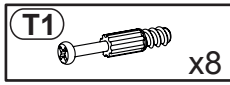
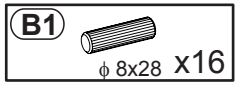

x4

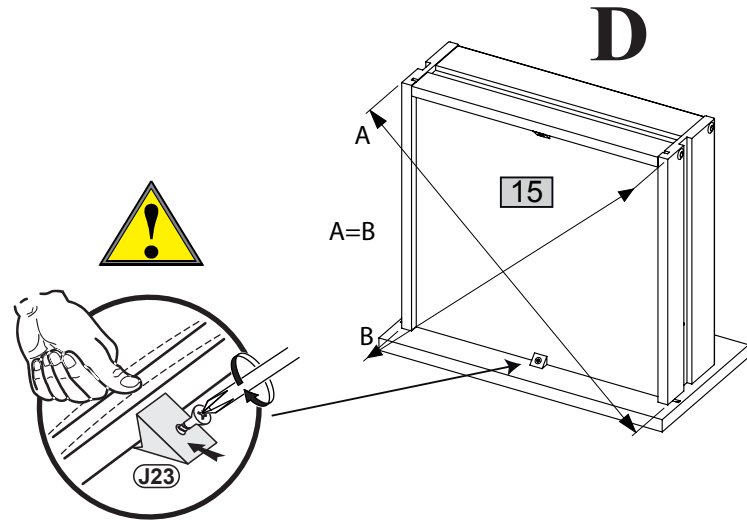
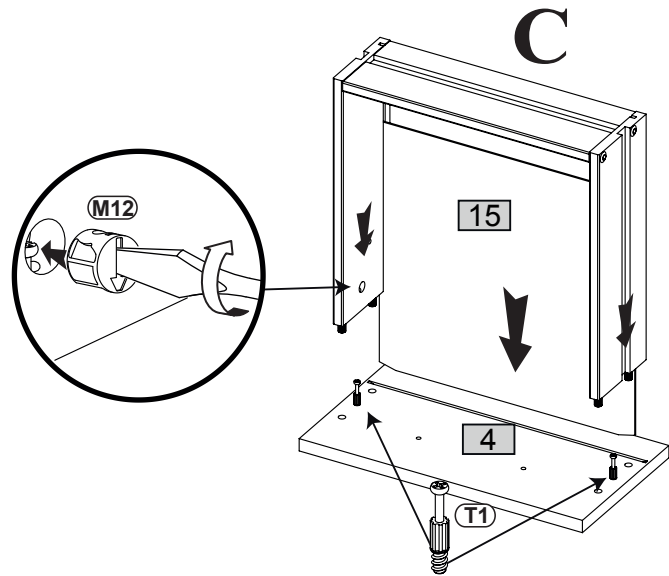
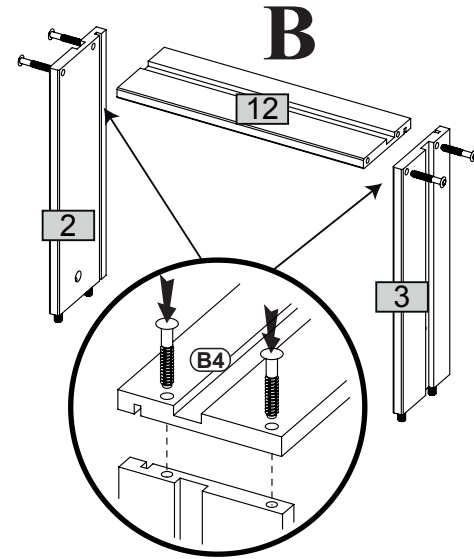

2

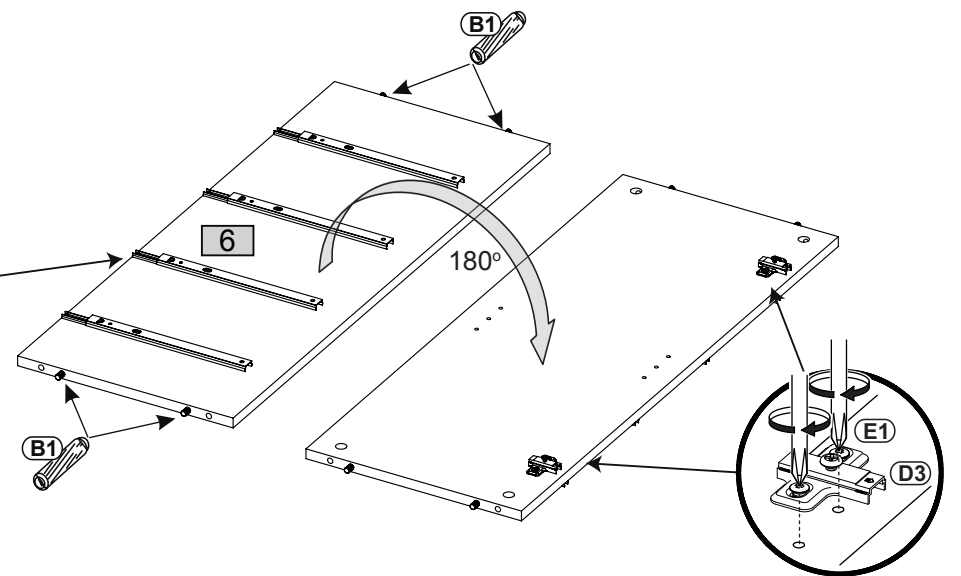
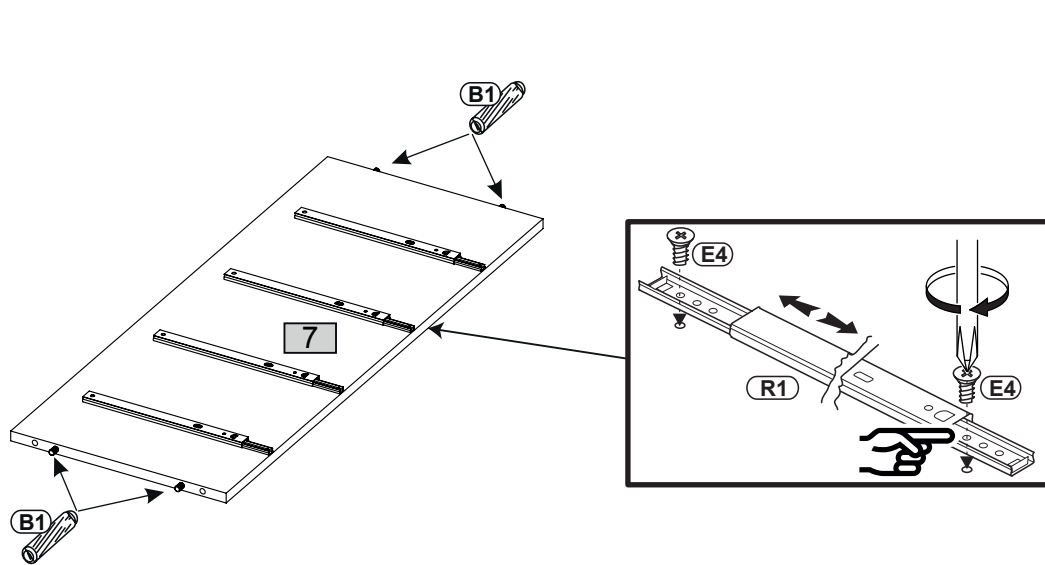
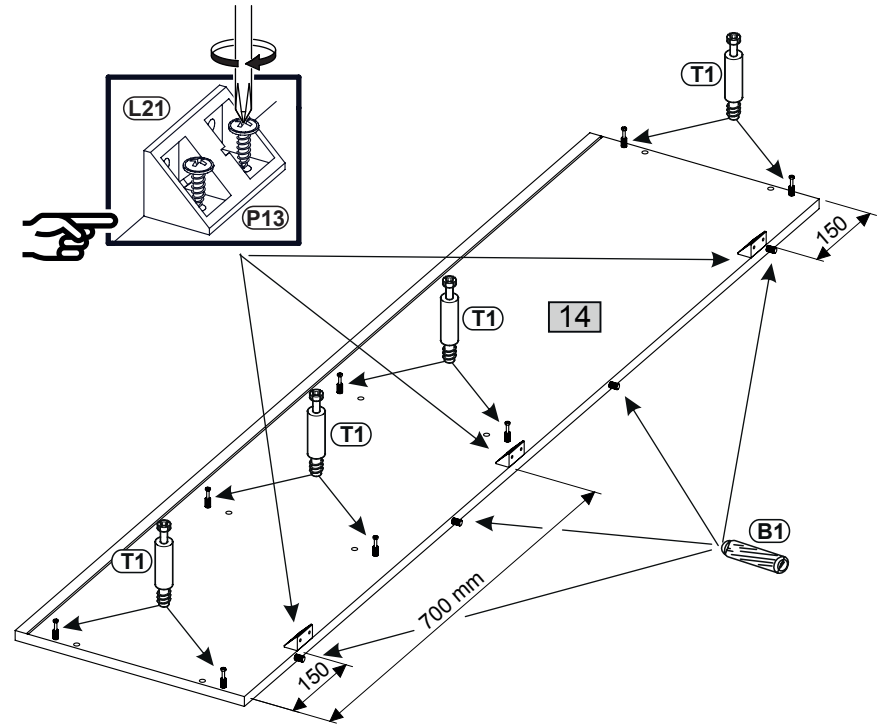
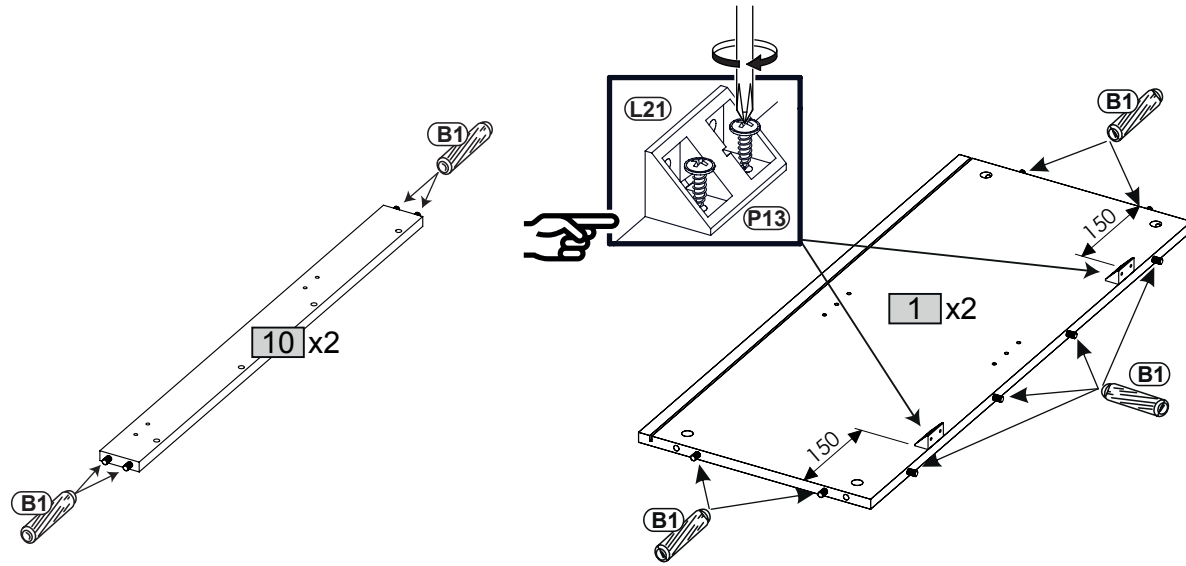
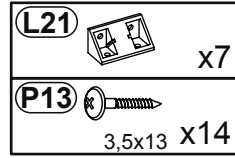
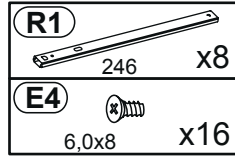
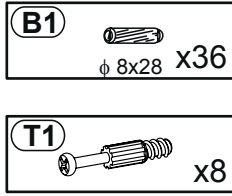
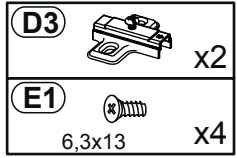

3

Z25		x4
S8		4x13 x12
Z2		KR8 x2

F10		x6
P17		4x20 x6

L21		x3
P13		3,5x13 x6

T1		x8
-----------	--	----

B1		φ 8x28 x4
-----------	--	-----------

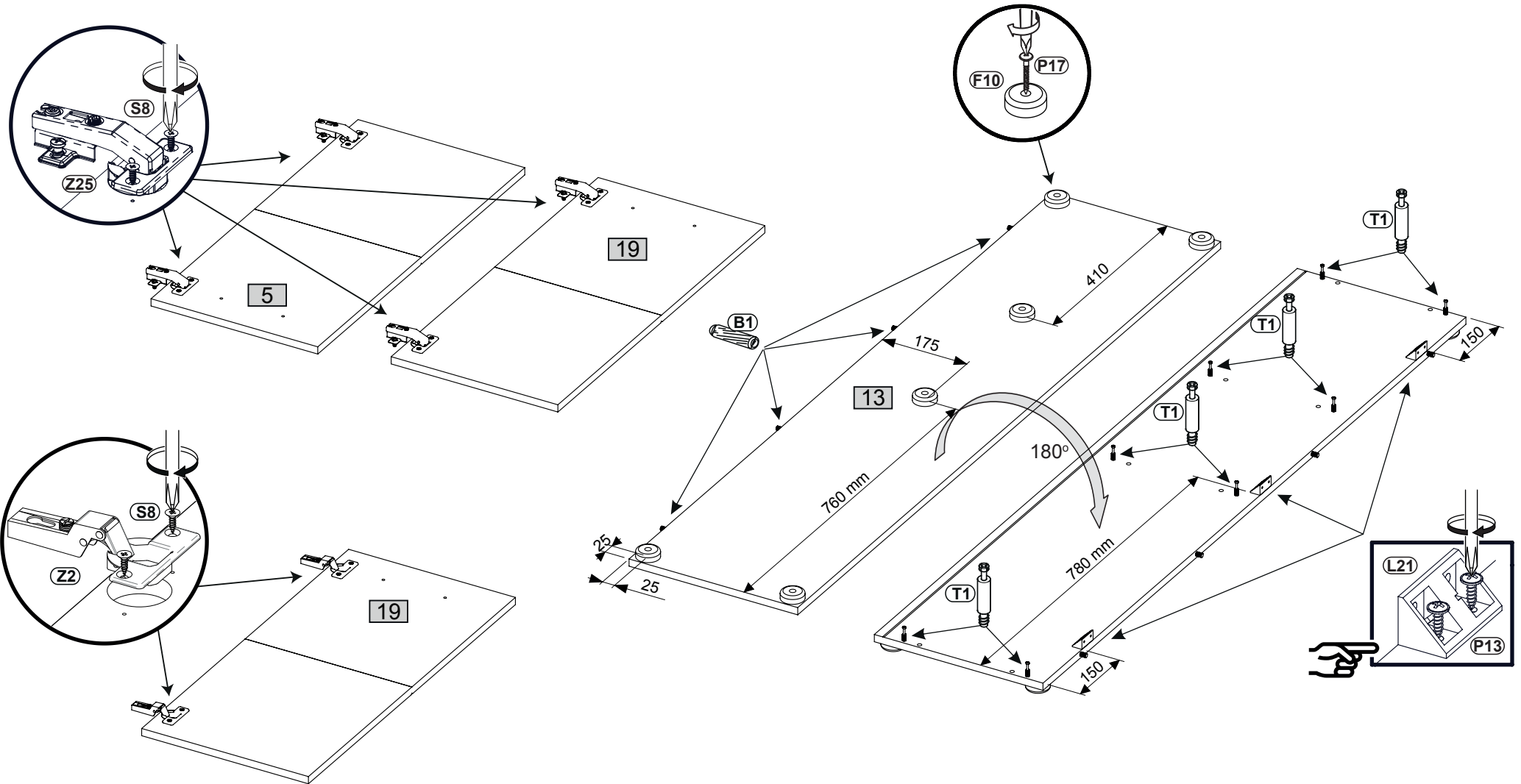

4

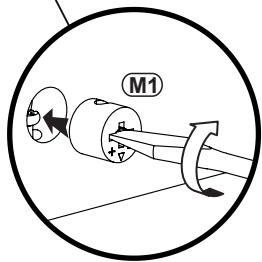
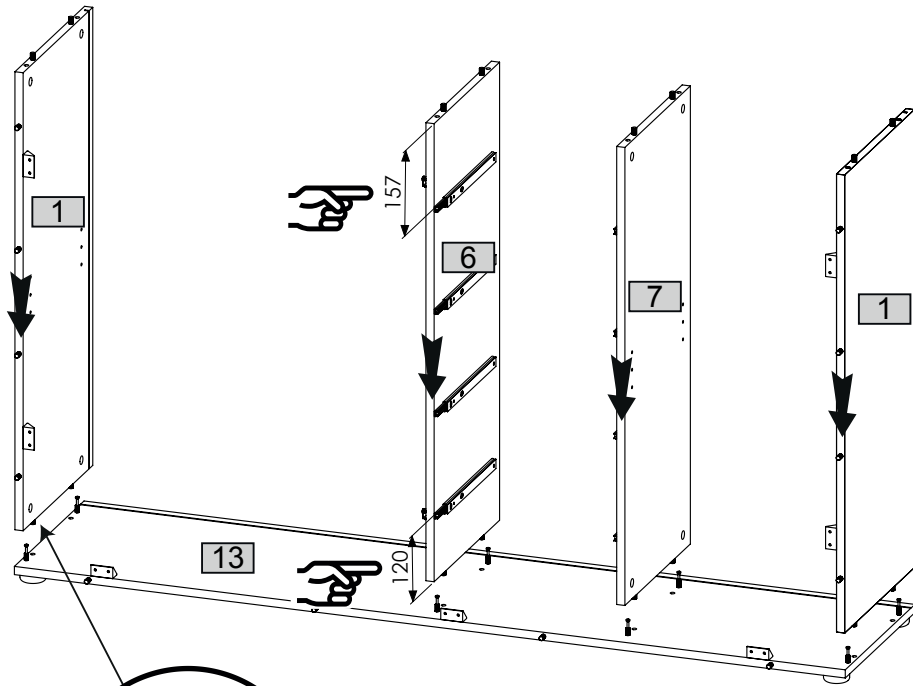

5

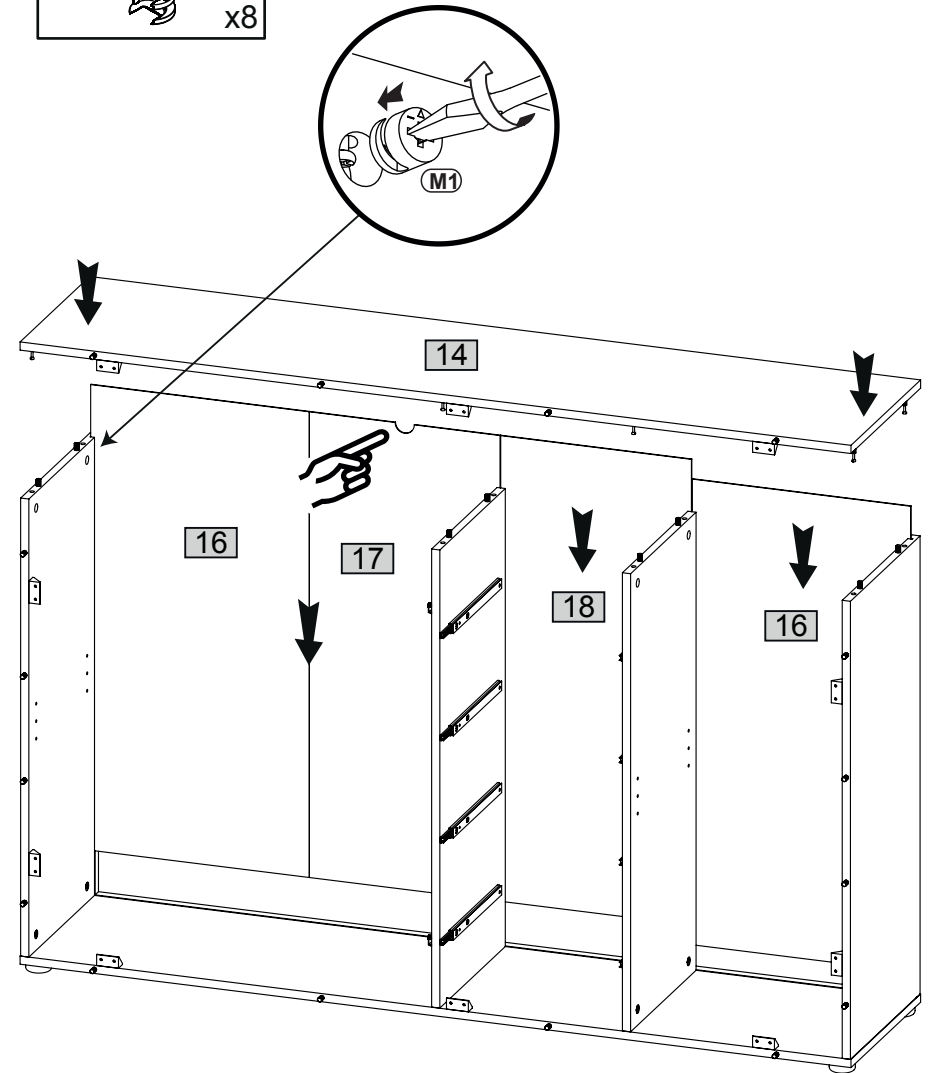

6

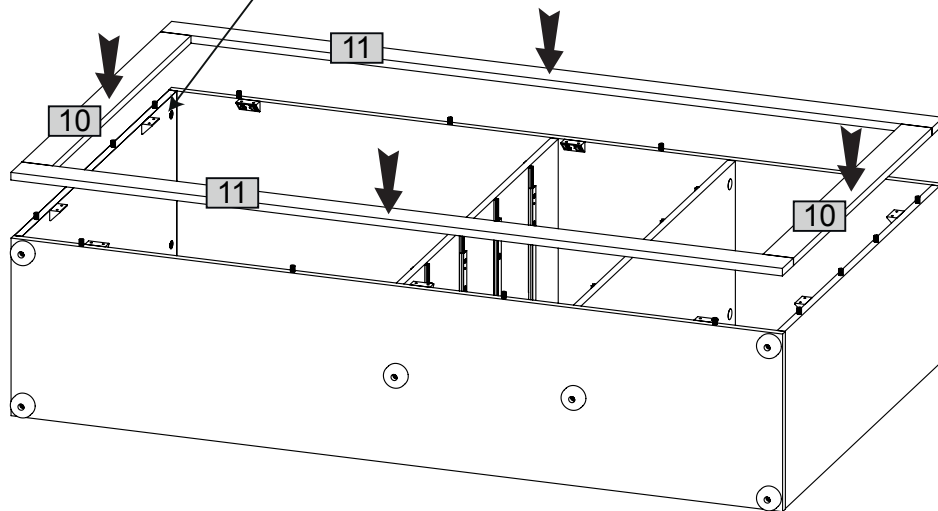
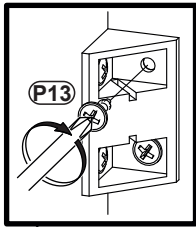
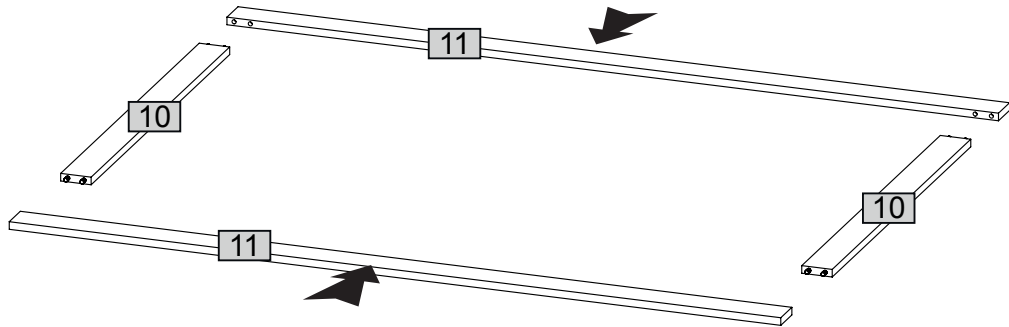
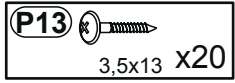

7

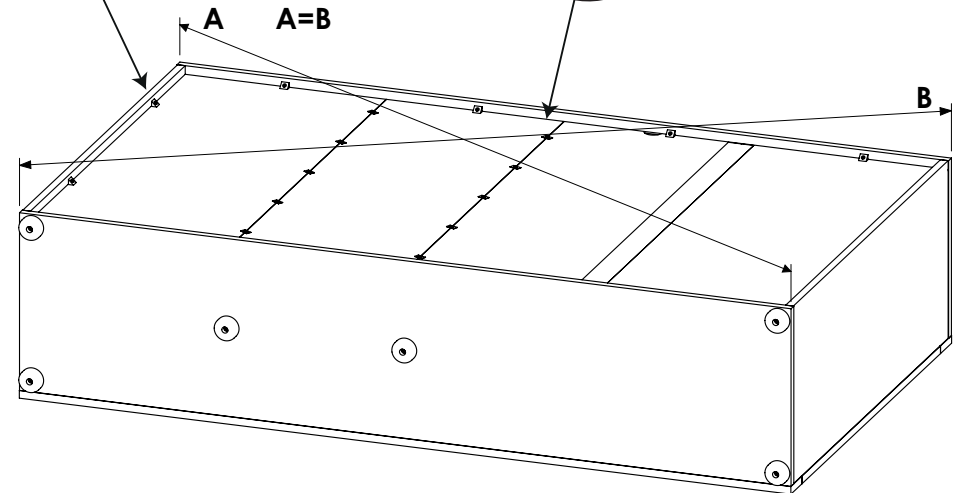
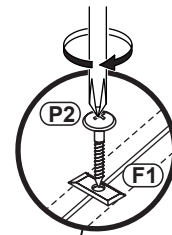
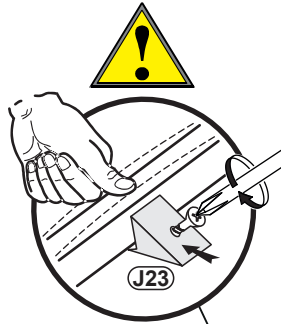
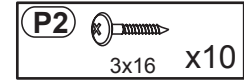
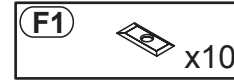
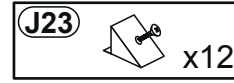

8

