

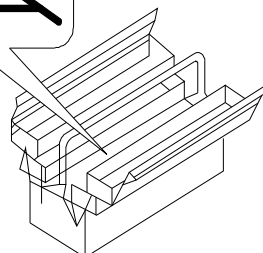

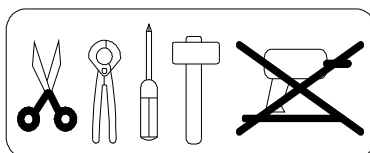

- | | |
|---------------------------------------|-----------------------------------|
| D Montageanleitung | GB Assembly instructions |
| NL Handleiding voor de montage | PL Instrukcja montazu |
| TR Montaj talimati | RU Инструкция по монтажу |
| FR Notice de montage | IT Istruzioni di montaggio |
| CS Montážní návod | SK Návod na montáž |
| HU Szerelési útmutató | RO Instrucțiuni de montaj |

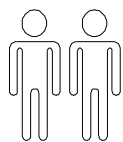

8001
1420x720

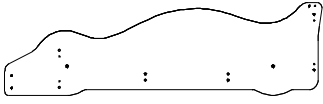
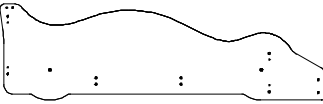
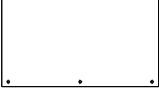
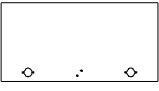
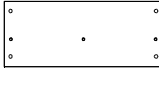
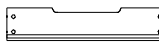
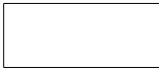
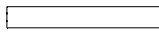
1 OF 7
TOTAL 7 PAGE
Ver1.013

SCTDRC

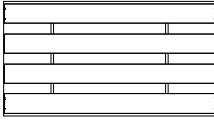
ITEM NO.	MEASUREMENT	QTY	SHAPE	CARTON NO.
①	1750 X 480 X 12	X1		1-1
②	1750 X 480 X 12	x1		1-1
③	720 X 360 X 12	x1		1-1
④	716 X 300 X 15	x1		1-1
⑤	720 X 275 X 12	x1		1-1
⑥	720 X 150 X 12	x1		1-1
⑦	720 X 246 X 12	x1		1-1
⑧	720 X 88 X 12	x1		1-1
⑨	720 X 80 X 15	x2		1-1
⑩	680 X 30 X 15	x2		1-1
⑪	292 X 292 X 18	x4		1-1
⑫	1417 X 690 X 12	x1		1-1

1420x720

2 OF 7

Ver1.013

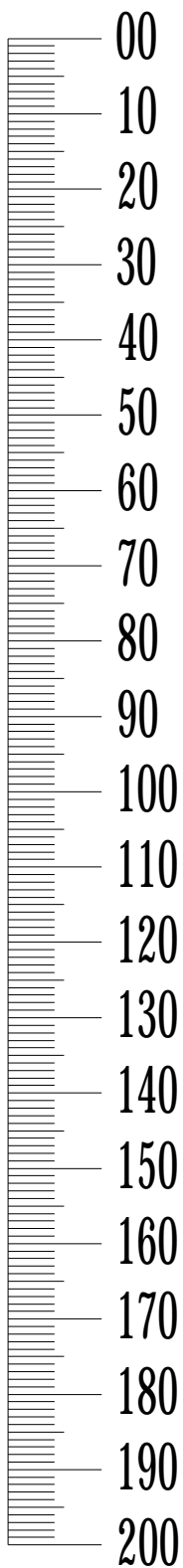

Service • Asistenza • Dienstverlening • Serwis Servis • Szerviz • Сервисная служба	
Name • Nom • Nome • Naam • Nazwa • Jméno • Názov • Név • Denumire • Isim • Название	
Nr. • No. • N° • Номер • Číslo • Sz	
Тур • Type • Típus • Tipus • Тіро • Тип	

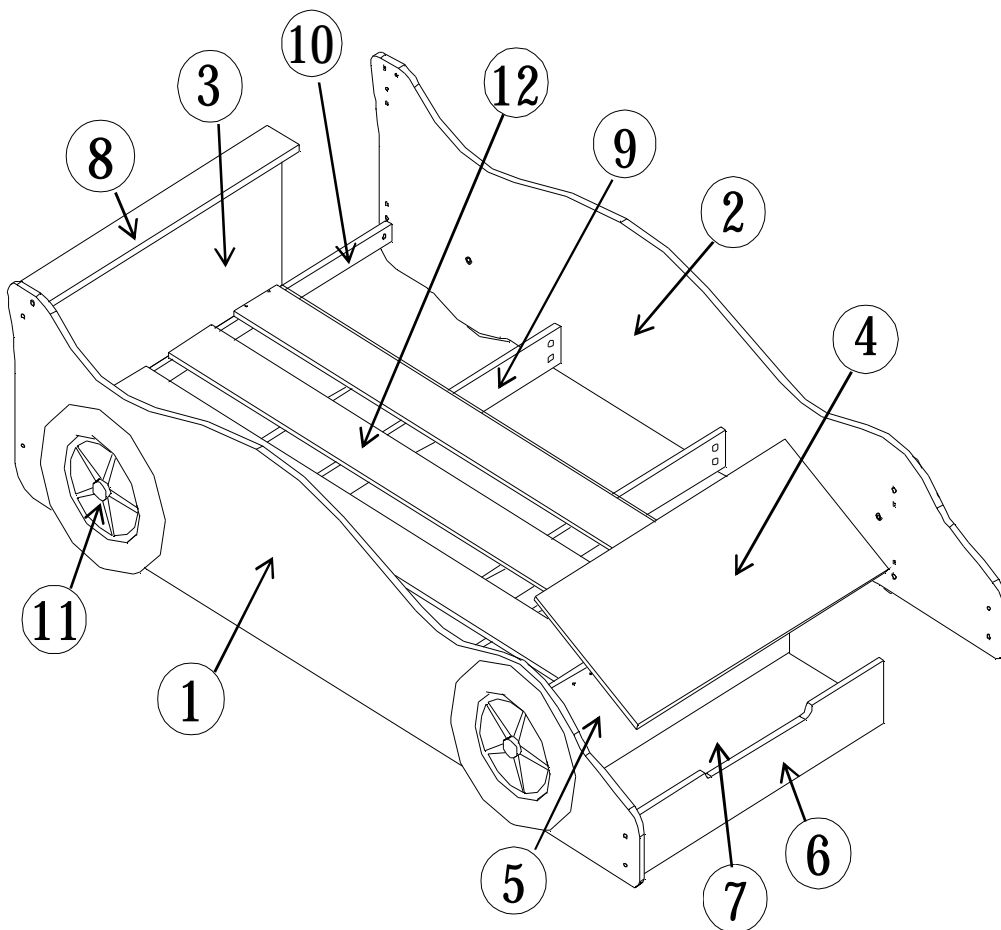

A x8	B x8	C 6x30 x12	D 10x9 x12	E 6x20 x10	E2 6x50 x12
F 3.5x12 x16	F2 3.5x29 x8	G x1	H x2	I x6	J Φ28x11 x4

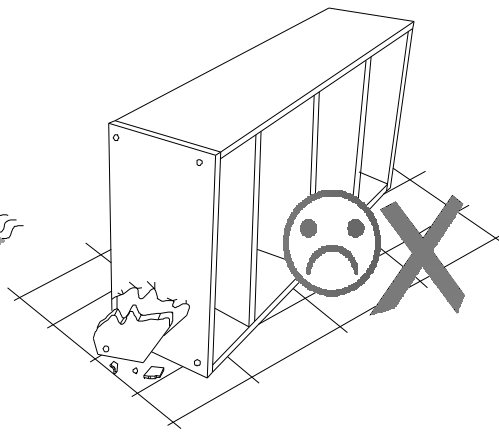
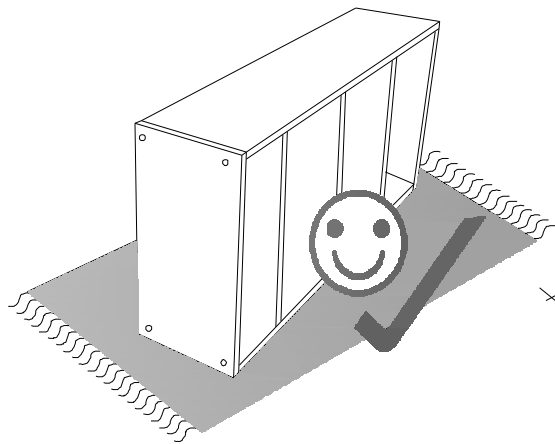

1

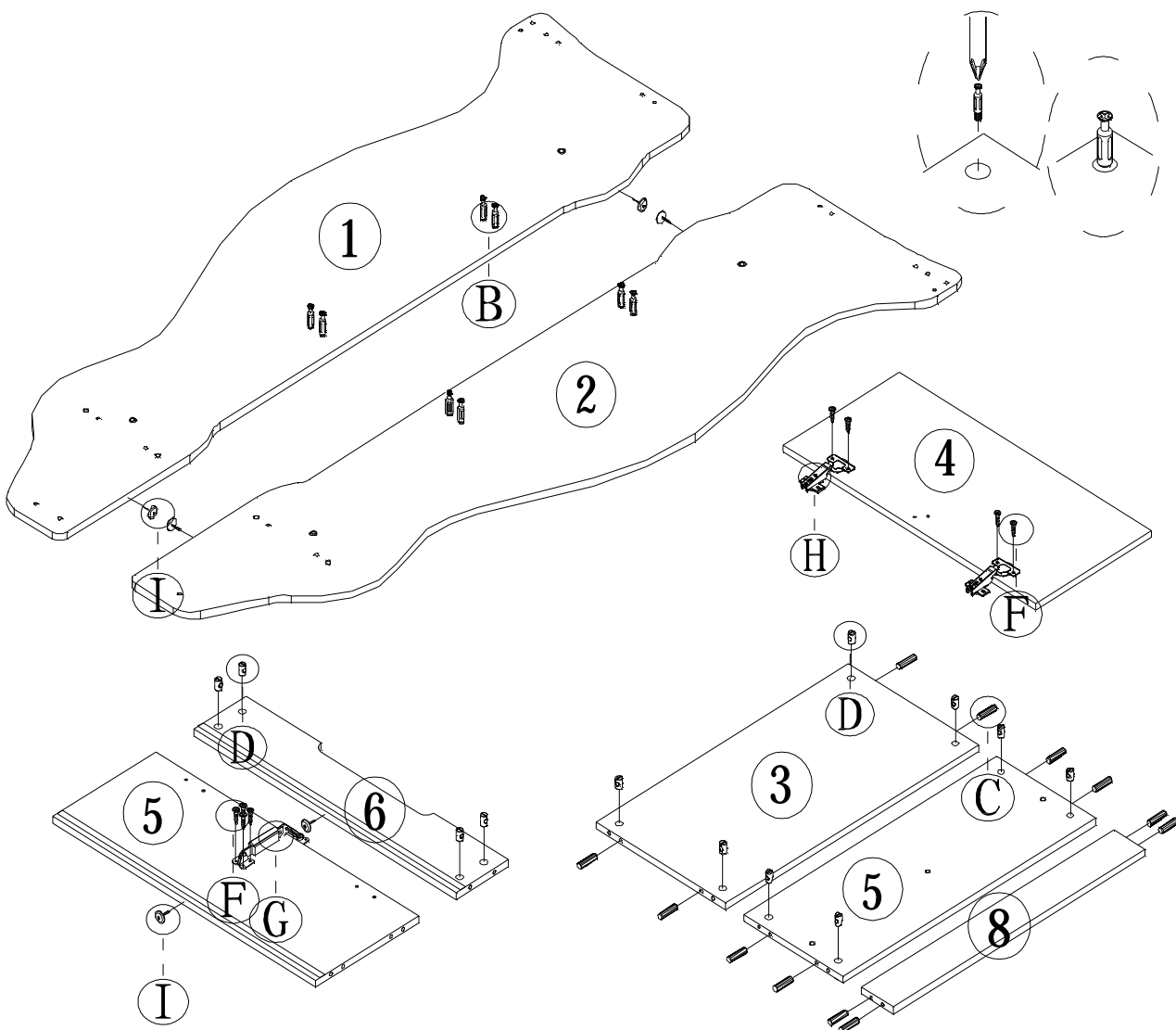
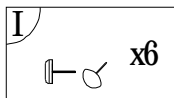
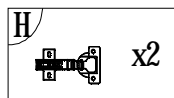
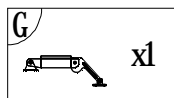
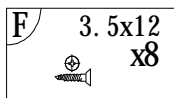
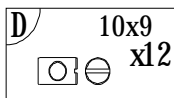
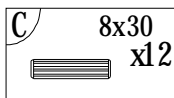
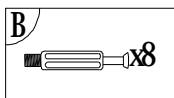

2

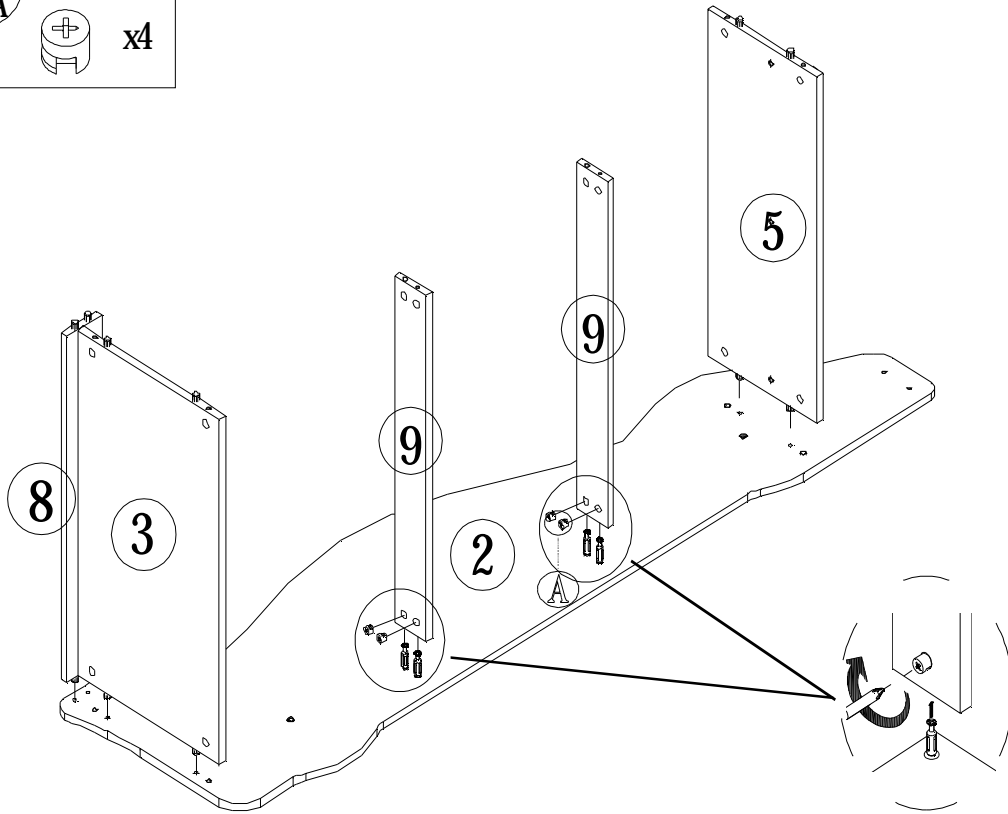
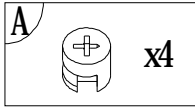

3

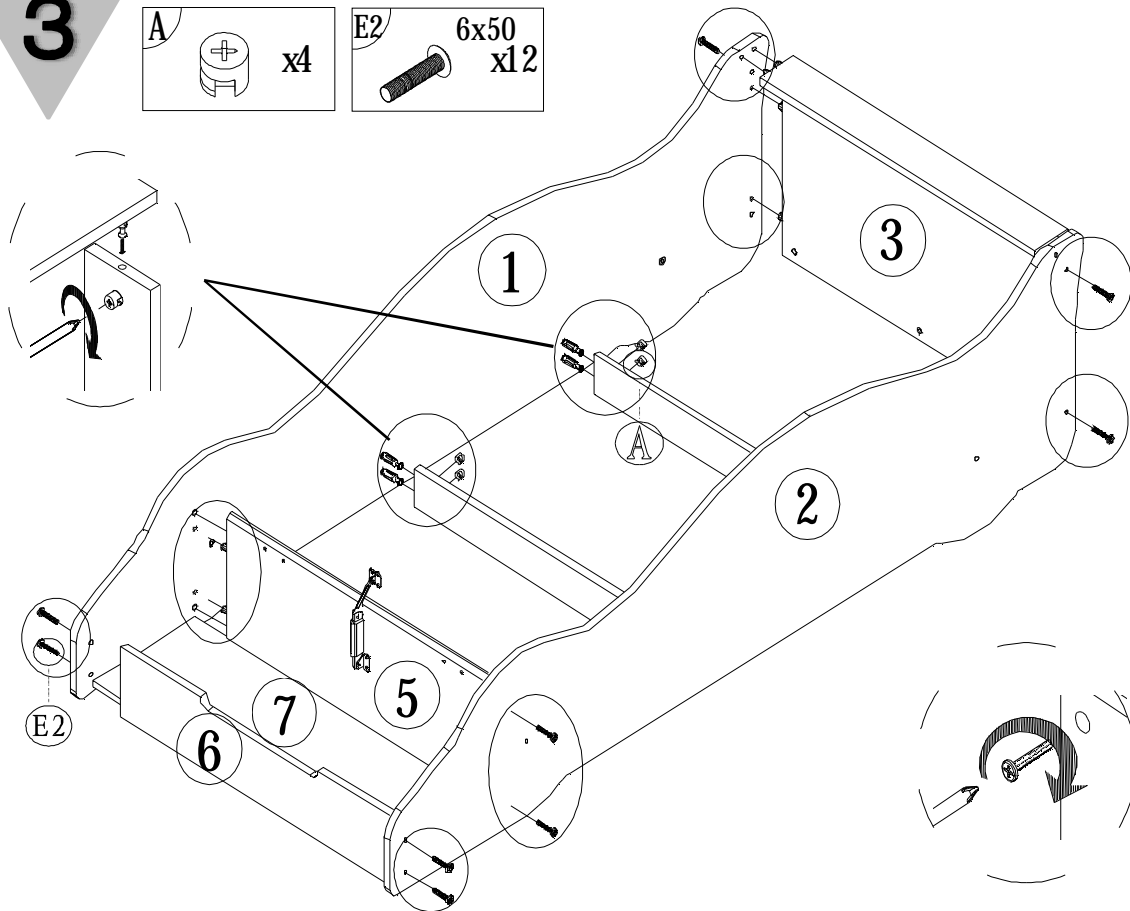
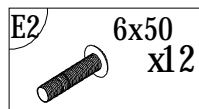
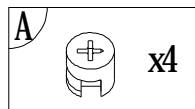

4

E 6x20
x10

J 28x11
x4

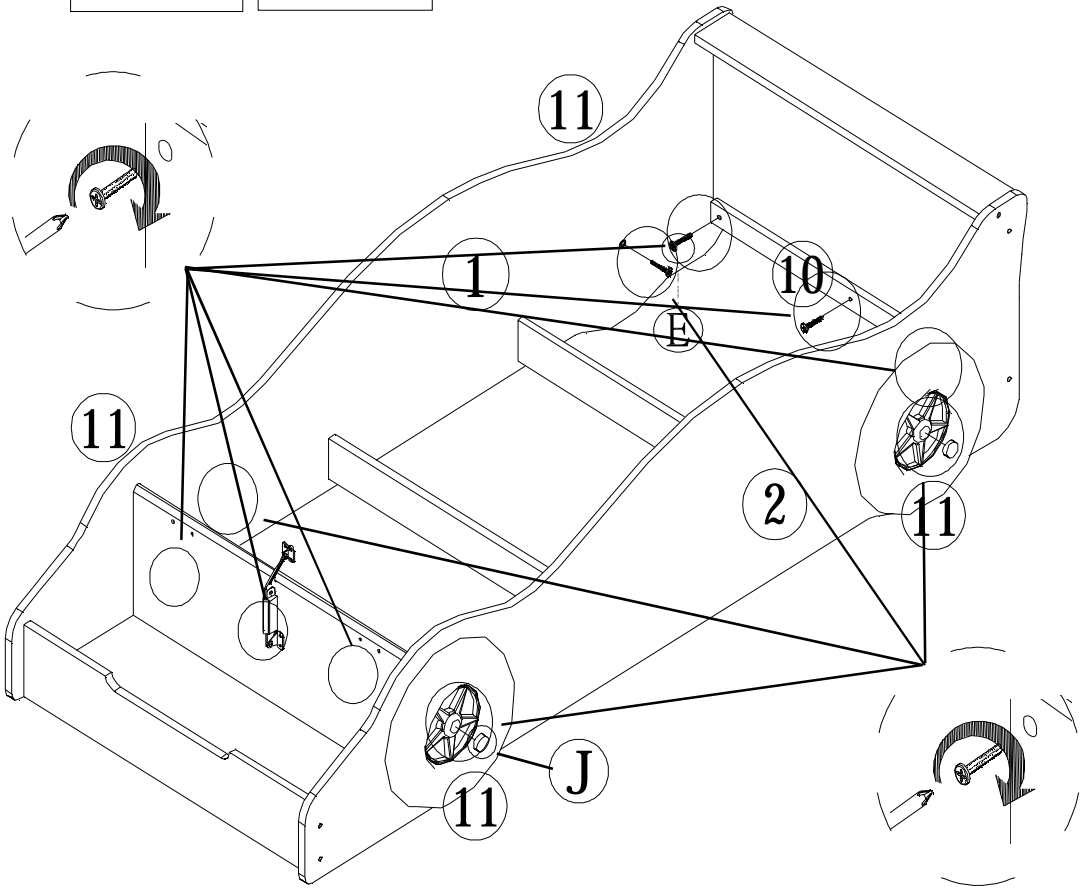

5

F 3.5x12
x8

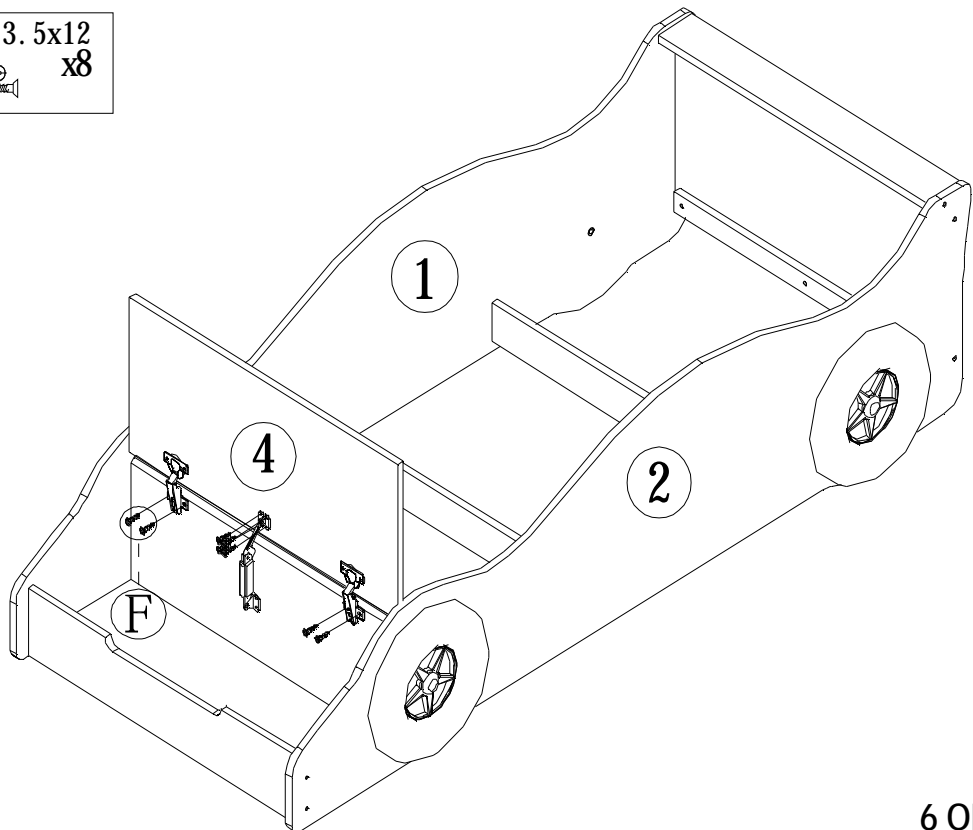

6

F2 3.5x29
x8

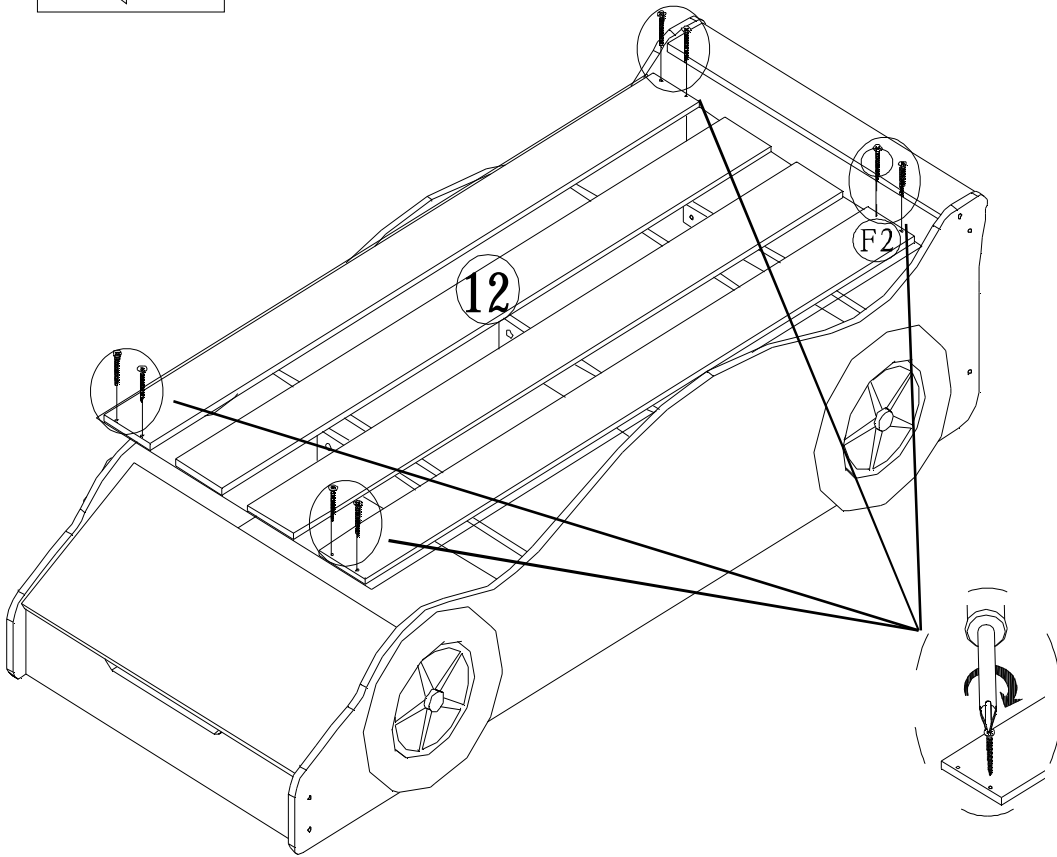

7

