

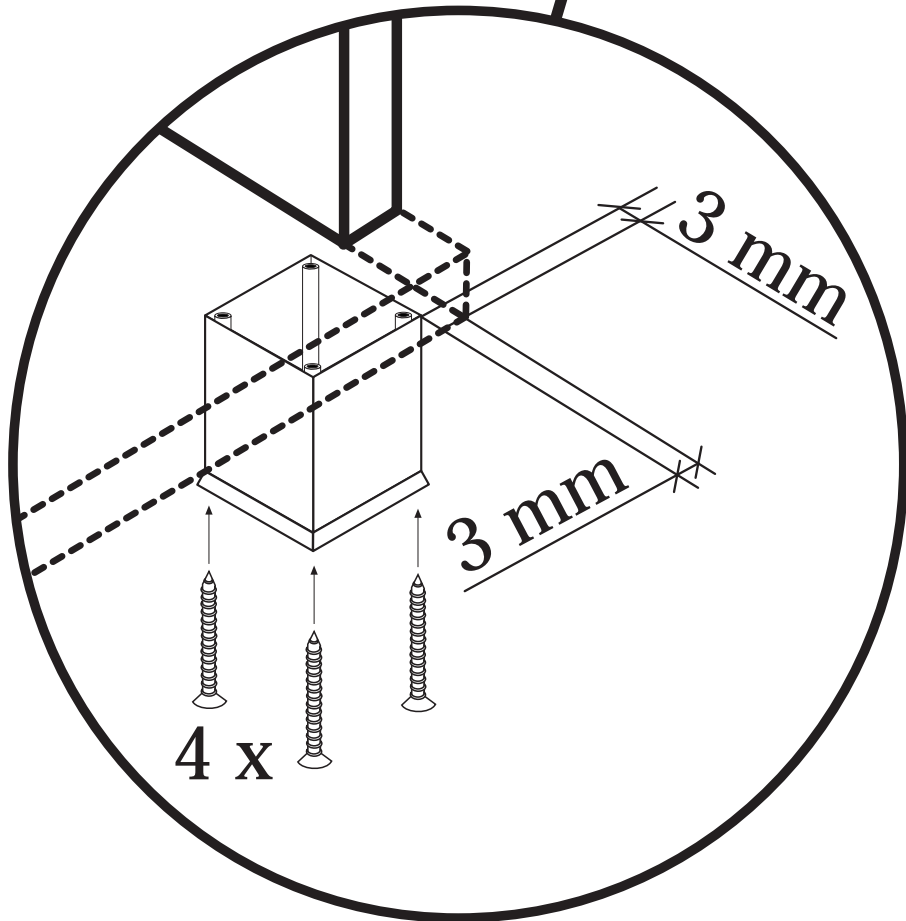

1 4551

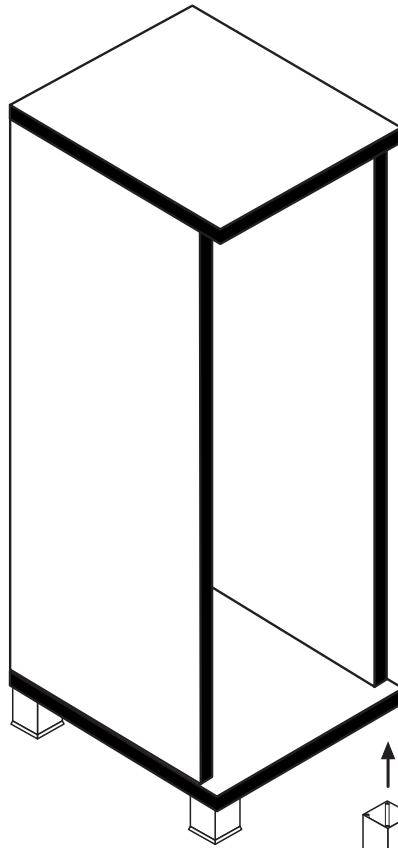

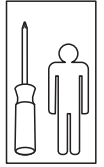
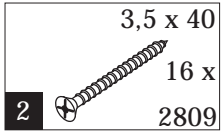

88130.527

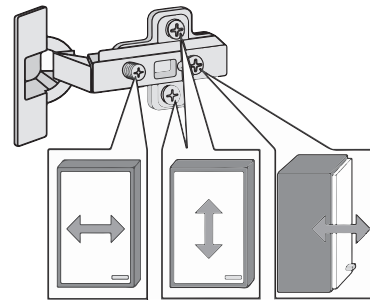
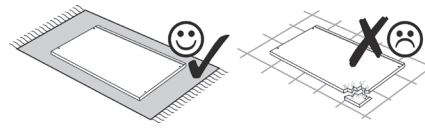
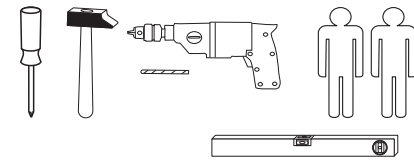

1 8 x 2802	2 8 x 2801	gedämpft 3 2 x 1504	ungedämpft 4 2 x 1505	5 4 x 1613
6 5 x 25 4 x 2860	7 8 x 30 8 x 2861	8 4 x 27 2 x 2829	9 5/5 x 16 12 x 2821	10 4 x 30 4 x 2812
11 5,8 x 55 2 x 2840	12 8 x 30 2 x 2842	13 2 x 2843	14 4 x 2865	15 3,5 x 15 10 x 2804
16 2 x	17 4 x	18 5mm 4 x	19 25 x 2862	20 Leim 1 x 2863

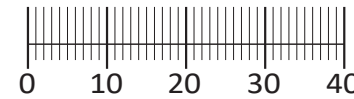

Das beigefügte Wandbefestigungsmaterial (Dübel und Schrauben) eignet sich nur für festes Mauerwerk (z.B.: Beton- oder Ziegelwände). Für andere Wandaufbauten sind eventuell Spezialdübel und andere Schrauben notwendig. Ziehen Sie gegebenenfalls eine Fachkraft zu Rate.

Приложенный материал для крепления к стене (дюбели и винты) пригоден только для жестких кладок (например, бетонные или кирпичные стены). Для других настенных конструкций необходимы смотря по обстоятельствам специальные дюбели и другие винты. При необходимости проконсультируйтесь у специалиста.

Załączony materiał do mocowania do ściany (kolki rozprężne i wkręty) nadaje się tylko do ścian murowanych (np. z betonu lub cegieł). Do ścian wykonanych w innych technologiach konieczne być mogą specjalne kolki rozprężne i inne wkręty. W razie potrzeby skorzystaj z fachowej pomocy.

The accompanying wall mounting hardware (anchors and screws) is suitable only for solid masonry (eg concrete or brick walls). For other wall structures are possibly special anchor bolts and other necessary. Tighten if necessary, an expert.

De begeleidende wandmontage hardware (pluggen en schroeven) is alleen geschikt voor massief metselwerk (bijvoorbeeld beton of bakstenen muren). Voor andere muur structuren zijn eventueel bijzondere ankerbouten en andere noodzakelijke. Draai indien nodig, een deskundige.

Le mur d'accompagnement matériel de montage (chevilles et les vis) ne convient que pour la maçonnerie solide (par exemple en béton ou des murs de briques). Pour les structures de mur d'autres sont peut-être spéciale boulons d'ancrage et d'autres nécessaires. Serrer le cas échéant, un expert.

Il muro di accompagnamento hardware di montaggio (tasselli e viti) è'e adatto solo per muratura piena (ad esempio calcestruzzo o muratura). Per le altre strutture murarie sono forse speciali bulloni di ancoraggio e necessari di altri. Serrare se necessario, un esperto.

Ekteki duvara sabit montaj malzemeleri (dübel ve vidalar), sadece sağlam duvarlar için (örnek: beton veya tuğla) elverişlidir. Başka duvarlar için özel dübeller ve farklı vidalar gerekebilir. Gerektiğinde bir uzmana danışınız.

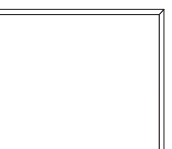
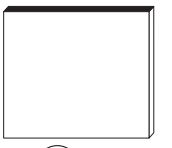
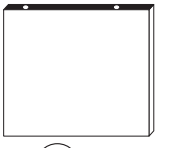
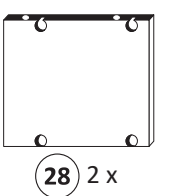
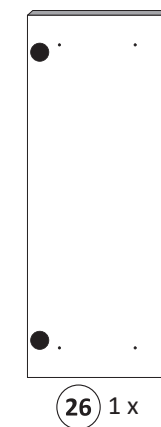
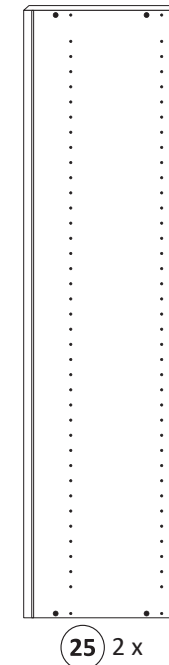

1

1 8 x 2802	5 4 x 1613	9 5/5 x 16 12 x 2821	10 4 x 30 4 x 2812	13 2 x 2843
----------------------	----------------------	-----------------------------------	---------------------------------	-----------------------

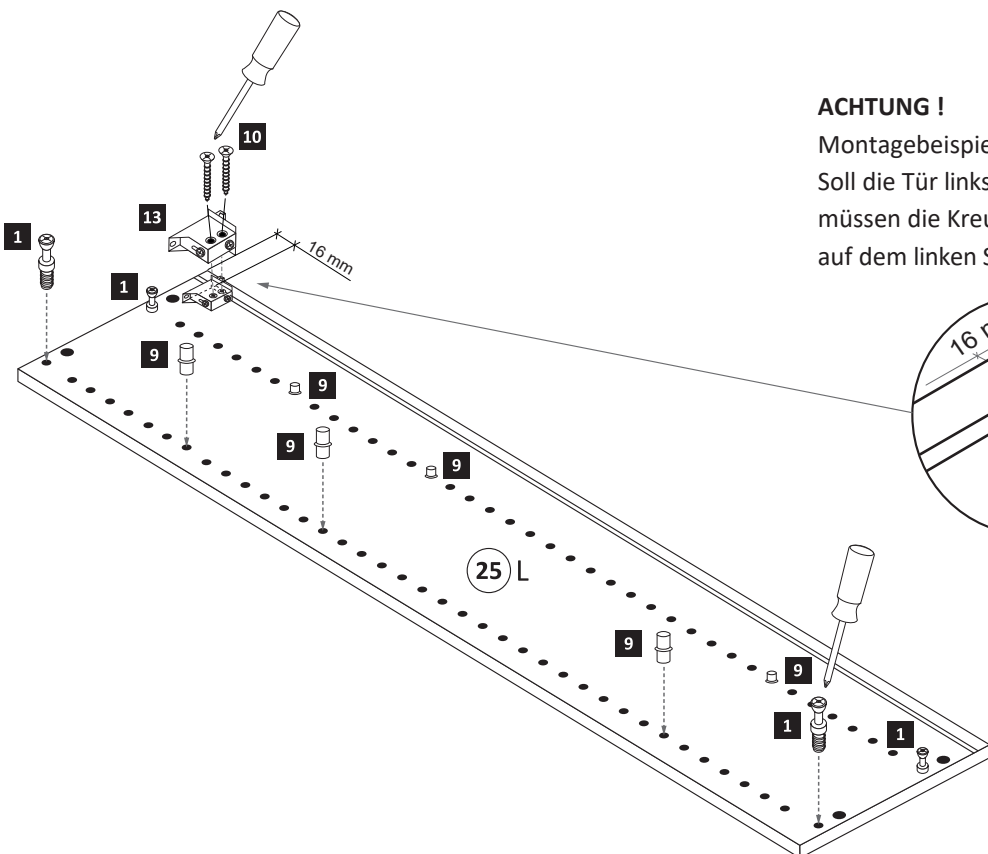

ACHTUNG !
Montagebeispiel Rechtsanschlag !
Soll die Tür links angeschlagen werden müssen die Kreuzmontageplatten **5** auf dem linken Seitenteil **25 L** montiert werden.

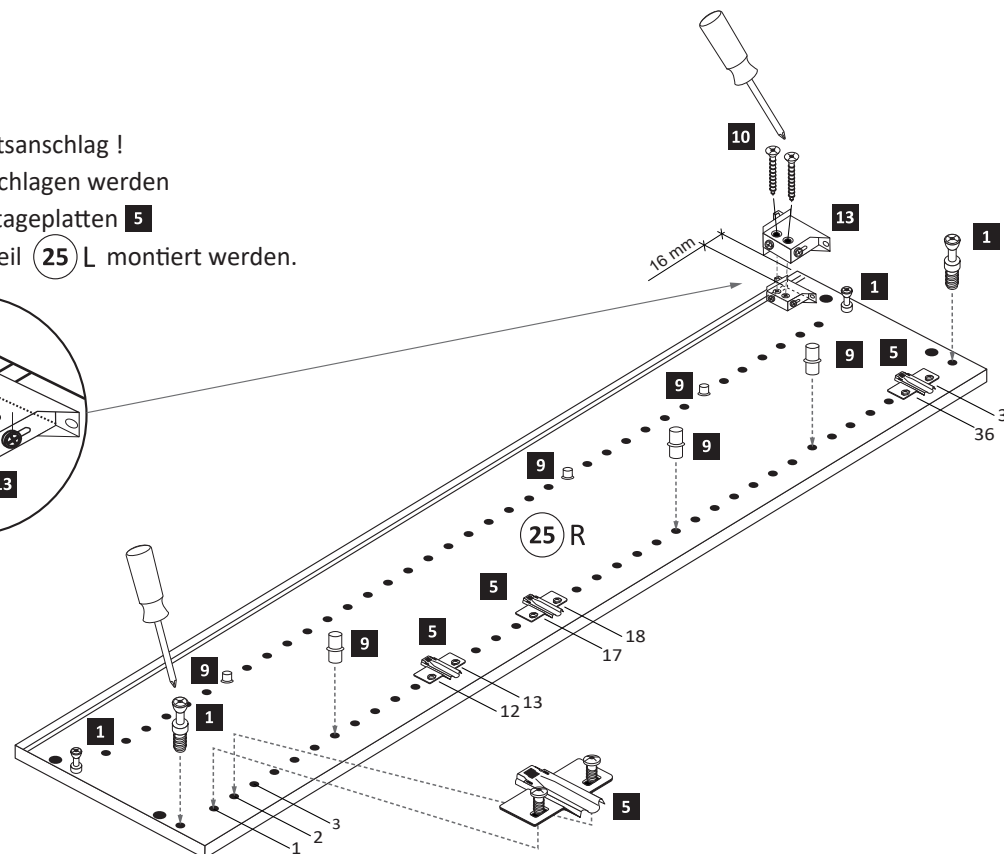
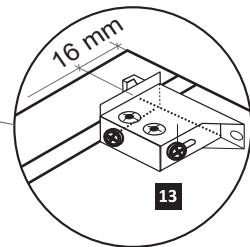

2

2 8 x 2801	6 5 x 25 4 x 2860	7 8 x 30 8 x 2861	20 Leim 1 x 2863
----------------------	--------------------------------	--------------------------------	-------------------------------

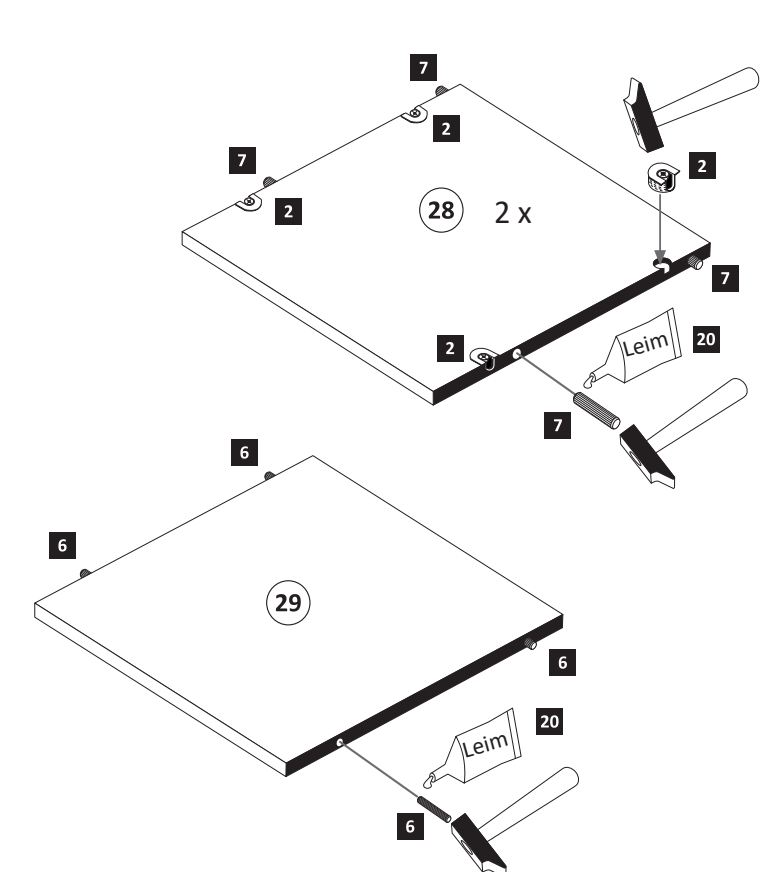

3

3,5 x 15	1 x 2863
2 x 2804	

20 min.

Leim

D Leim
GB Glue
NL Lijm
PL Klej
TR Tutkal
F Colle
I Colla

5

25 x 2862

6

gedämpft	ungedämpft	3,5 x 15
2 x 1504	2 x 1505	8 x 2804
	4 x 2865	

ACHTUNG !
Montagebeispiel Rechtsanschlag !
Sollen die Türen links angeschlagen werden,
müssen die anderen Griffbohrungen
durchgebohrt werden.

4

4 x 27	1 x 2829
2 x 2829	

7

2 x 16	4 x 17	4 x 18	5mm
--------	--------	--------	-----

Scharniermontage

Scharnier lösen

8

5,8 x 55	8 x 30
2 x 2840	2 x 2842